



BEV RITE[®]

Beverage Dispensing Equipment

683 Bonded Parkway
Streamwood, IL 60107
sales@chillpassion.com
Phone: 630.372.7005 Fax: 630.823.8486

Chill Passion
www.chillpassion.com

Wholesale

2022

Rev. 2022.1



Chill Passion is a manufacturer and distributor of high quality beverage dispensing products. While most of the items are manufactured to our specification under our brand name, we also carry products from other high quality manufacturers and are proud of our relationships with those companies. We make every effort to provide best possible products. Many of our products are manufactured or assembled in the USA.

We serve a wide variety of customers including Resellers, Installers, Restaurants, Bars and other manufacturers all over North America. We appreciate all the support and love that our customers have provided over the years. Contact us if you would like to get more information about an account.

This catalog is provided for wholesale / commercial customers only.

Contents

Beverage Dispense Towers Pipe Towers, Pass thru , T Towers. Counter and Wall Mount. For Beer, Wine, Water and Coffee. Glycol and Air Cooled.	4 – 13
Drip Trays Various sizes available. With or without drain. Rinsers included in some models.	14-16
Faucets Various types available. Chrome, Polished Brass and SS 304 grade.	17 – 20
Shanks Chrome and SS304 grade. New sizes added. Shank parts available.	21 – 23
Hose, Fittings and Tools	24– 26
Keg Couplers D, S, A, U, G styles. Available with Chrome and SS304 probes.	27
Gas Line Supplies Regulators, Assembled Regulator Panels, Manifolds, Parts etc.	28 – 32
Trunk Line, FOB, Pumps and Motors	33 - 34
Glycol Chillers	35
Direct Draw Coolers	36
Line Cleaning Products Beer Line Cleaning Chemical, Brushes and other parts	37 – 38
Event Dispensing, Jockey Boxes Picnic Pumps, Uber Tap, CO2 dispensing, Jockey Boxes, Coils, Parts	39 – 42
Soda Parts , Home Brew Parts and Kits	43 – 47

Brew Pipe Towers



Made in USA

Brooklyn U Towers : 3" Pipe

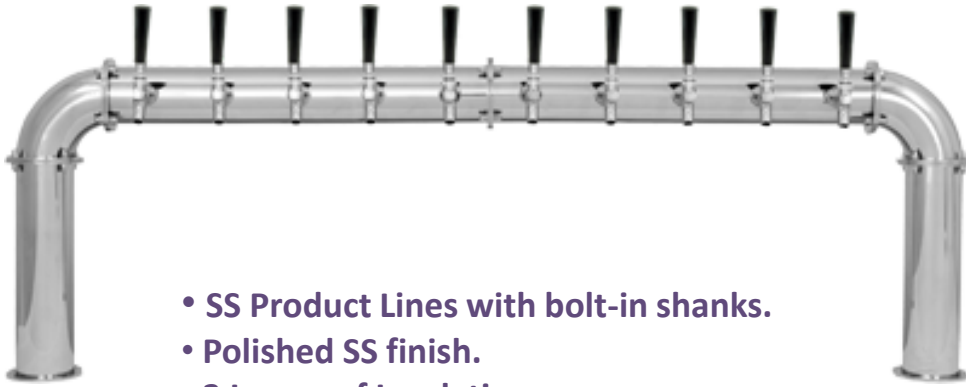

- SS Product Lines with bolt-in shanks.
- Polished SS finish.
- 3 Layers of Insulation.

All Towers can be made with unlimited number of faucets (T or Y joint and extra pedestals will be added).

Custom Requests Welcome.

Air Cooled Chrome Contact	Air Cooled SS Contact	Glycol Ready Chrome Contact	Glycol Ready SS 304 Contact	3" Pipe Towers Polished SS Finish	Drip Tray Length
CT3P4	CT3P4SS	CT3P4-GL	CT3P4SS-GL	4 Faucet – 23 1/2" wide	12"
CT3P5	CT3P5SS	CT3P5-GL	CT3P5SS-GL	5 Faucet– 26 1/2" wide	15"
CT3P6	CT3P6SS	CT3P6-GL	CT3P6SS-GL	6 Faucet– 29 1/2" wide	18"
CT3P8	CT3P8SS	CT3P8-GL	CT3P8SS-GL	8 Faucet– 35 1/2" wide	24"
CT3P10	CT3P10SS	CT3P10-GL	CT3P10SS-GL	10 Faucet– 41 1/2" wide	30"
CT3P12	CT3P12SS	CT3P12-GL	CT3P12SS-GL	12 Faucet– 47 1/2" wide	36"

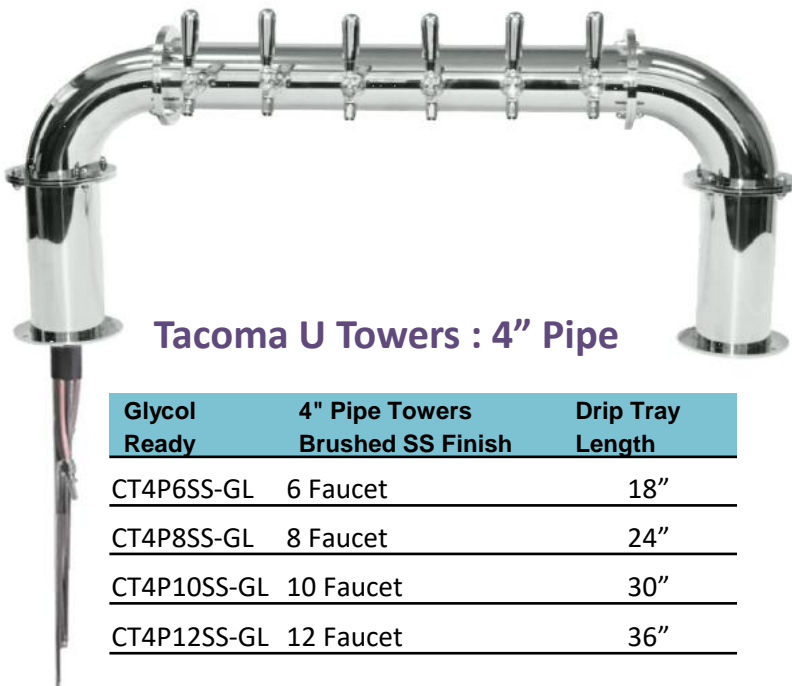

Tacoma U Towers : 4" Pipe

Glycol Ready	4" Pipe Towers Brushed SS Finish	Drip Tray Length
CT4P6SS-GL	6 Faucet	18"
CT4P8SS-GL	8 Faucet	24"
CT4P10SS-GL	10 Faucet	30"
CT4P12SS-GL	12 Faucet	36"

- SS Product Lines with bolt-in shanks.
- Brushed finish (Polished for 8% more).
- 3 Layers of Insulation.

Grande U Towers : 6" Pipe

Glycol Ready	6" Pipe Towers Brushed SS Finish	Drip Tray Length
CT6P6SS-GL	6 Faucet Glycol	18"
CT6P8SS-GL	8 Faucet Glycol	24"
CT6P10SS-GL	10 Faucet Glycol	30"
CT6P12SS-GL	12 Faucet Glycol	36"

- All Glycol Ready Towers on this page come with SS Lines and bolt-in shanks.
- Air cooled versions can be made for most towers (upto 12 faucets).



Made in USA

Brooklyn L Towers : 3" Pipe

Polished SS Finish - SS304 contact

Glycol Ready	3" Pipe Towers Polished SS Finish
CT3PL4SS-GL	4 Faucet Glycol
CT3PL5SS-GL	5 Faucet Glycol
CT3PL6SS-GL	6 Faucet Glycol

Tacoma L Towers : 4" Pipe

Brushed SS Finish - SS304 contact

Glycol Ready	4" Pipe Towers Brushed SS Finish
CT4PL4SS-GL	4 Faucet Glycol
CT4PL5SS-GL	5 Faucet Glycol
CT4PL6SS-GL	6 Faucet Glycol



Y Towers

Brushed SS Finish - SS304 contact

Item	Brushed SS Body – 4" Pipe All SS contact
CT4Y6SS-GL	6 Faucet Glycol
CT4Y8SS-GL	8 Faucet Glycol
CT4Y10SS-GL	10 Faucet Glycol
CT4Y12SS-GL	12 Faucet Glycol



Metro Style Towers

Polished SS Finish on all Metro Towers



Item	Metro H - Glycol Ready
CTMH8SS-GL	8 Faucet – SS304 Contact
CTMH10SS-GL	10 Faucet – SS304 Contact
CTMH12SS-GL	12 Faucet – SS304 Contact
CTMH14SS-GL	14 Faucet – SS304 Contact
CTMH16SS-GL	16 Faucet – SS304 Contact



Glycol Ready	Metro T	Air Cooled	Metro T
CTMT4SS-GL	4 Faucet - SS304 Contact	CTMT4	4 Faucet – Chrome Plated Brass Contact
CTMT6SS-GL	6 Faucet - SS304 Contact	CTMT6	6 Faucet – Chrome Plated Brass Contact
CTMT8SS-GL	8 Faucet - SS304 Contact	CTMT4SS	4 Faucet - SS304 Contact
		CTMT6SS	6 Faucet - SS304 Contact

Pass Thru Towers



Item	Pass Thru Towers- Glycol Ready Brushed SS Finish
CTPT8SS-GL	8 Faucet – SS304 Contact
CTPT10SS-GL	10 Faucet – SS304 Contact
CTPT12SS-GL	12 Faucet – SS304 Contact
CTPT14SS-GL	14 Faucet – SS304 Contact
CTPT16SS-GL	16 Faucet – SS304 Contact

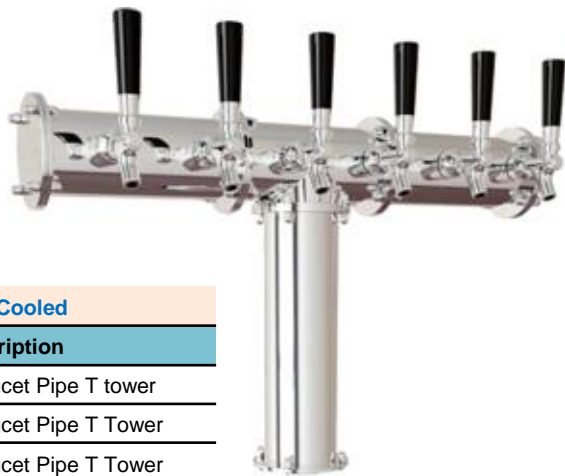

Brooklyn T Towers : 3" Pipe

Air Cooled	
Item	Description
CPUT4	4 Faucet Pipe T tower
CPUT6	6 Faucet Pipe T Tower
CPUT8	8 Faucet Pipe T Tower

Glycol Ready		
Item	Description	Drip Tray Length
CPUT4SS-GL	4 Faucet Pipe T tower	16"
CPUT6SS-GL	6 Faucet Pipe T Tower	20"
CPUT8SS-GL	8 Faucet Pipe T Tower	30"
CPUT10SS-GL	10 Faucet Pipe T Tower	36"
CPUT12SS-GL	12 Faucet Pipe T Tower	40"
CPUT14SS-GL	14 Faucet Pipe T Tower	45"



The Miami Tower

- All Miami towers are glycol ready.
- Includes 1/4" ID SS 304 tubes for Beer Line.
- Purchase shank and faucet set separately (European flow control or US Standard)
- Faucet knobs not included.

* Polished brass finish available on special order.

Item	Description
CMMT1	Miami Beer Tower Single Faucet (Purchase shank/faucet set separately)
CMMT2	Miami Beer Tower Double Faucet (Purchase shank/faucet set separately)
CMMT3	Miami Beer Tower Triple Faucet (Purchase shank/faucet set separately)
CMMT4	Miami Beer Tower Four Faucet (Purchase shank/faucet set separately)

Item	Description
CFP10	European Style Flow Control Shank and Faucet Set
CFP11	Standard US Shank (SS) and Chrome faucet Set
CFS12	Standard US Shank(SS) and SS304 faucet (All contact SS304)
CSS252	Standard US shank SS – to fit Miami tower
CPC300.60	Round Label Holder



Sexy Tower

- All Sexy towers are glycol ready.
- Sold without Faucets. Purchase faucets separately.

Item	Description
CTSX2	2 Product Sexy Tower, Stainless Tubes and Shanks, Chrome finish
CTSX4	4 Product Sexy Tower, Stainless Tubes and Shanks, Chrome finish

See page 14 for platform drip trays.



Box Towers – Air or Glycol Ready



Made in USA



Features

- Includes Standard US Faucets and mounting hardware.
- Pre-Fitted with 3/16" ID tubing and beer nut.
- Total height : 15".
- 304 Grade SS Body with welded flange for durability.

**Faucet knobs sold separately
For all towers on this page
(Item# C186)**

Upgrade to SS faucets and shanks available for an upcharge

T Box Tower with 3" round pedestal

Item ("GL" is for Glycol Ready)	Description
CTT3 / CTT3-GL	3 Faucets – Box width: 10"
CTT4 / CTT4-GL	4 Faucets – Box Width: 13"
CTT5 / CTT5-GL	5 Faucets – Box Width: 16"
CTT6 / CTT6-GL	6 Faucets – Box Width: 19"
CTT8 / CTT8-GL	8 Faucets – Box Width: 25"

T Box Tower with 4" round pedestal

Item ("GL" is for Glycol Ready)	Description
CTT4-4/ CTT4-4-GL	4 Faucets – Box Width: 13"
CTT5-4 / CTT5-4-GL	5 Faucets – Box Width: 16"
CTT6-4 / CTT6-4-GL	6 Faucets – Box Width: 19"
CTT8-4 / CTT8-4-GL	8 Faucets – Box Width: 25"
CTT10-4 / CTT10-4-GL	10 Faucets – Box width: 31"



Pass-through box tower - 3" round columns

Item ("GL" is for Glycol Ready)	Description
CTT6P / CTT6P-GL	6 Faucets – Box Width: 19"
CTT8P / CTT8P-GL	8 Faucets – Box Width: 25"
CTT10P / CTT10P-GL	10 Faucets – Box Width: 31"
CTT12P / CTT12P-GL	12 Faucets – Box Width: 37"

Pass-through box with 4" columns

Item ("GL" is for Glycol Ready)	Description
CTT6P-4 / CTT6P-4-GL	6 Faucets – Box Width: 19"
CTT8P-4 / CTT8P-4-GL	8 Faucets – Box Width: 25"
CTT10P-4 / CTT10P-4-GL	10 Faucets – Box Width: 31"
CTT12P-4 / CTT12P-4-GL	12 Faucets – Box Width: 37"
CTT14P-4 / CTT14P-4-GL	14 Faucets – Box Width: 43"
CTT16P-4 / CTT16P-4-GL	16 Faucets – Box Width: 49"

- Available in upto 24 faucets.

-30 faucet Tower can be made with 3 Pedestals.



Dual sided - with 4" columns

Item (Glycol)	Description
CTT12D-GL	T Tower, 12 Faucets total – Box Width: 19"
CTT16D-GL	T Tower, 16 Faucets total – Box Width: 25"
CTT16PD-GL	Pass Thru, 16 Faucets total – Box Width: 25"
CTT20PD-GL	Pass Thru, 20 Faucets total – Box Width: 31"
CTT24PD-GL	Pass Thru, 24 Faucets total – Box Width: 37"
CTT28PD-GL	Pass Thru, 28 Faucets total – Box Width: 43"
CTT32PD-GL	Pass Thru, 32 Faucets total – Box Width: 49"
CTT36PD-GL	3 Pedestals, 36 Faucets total – Box Width: 55"
CTT40PD-GL	4 Pedestals, 40 Faucets total – Box Width: 61"
CTT48PD-GL	4 Pedestals, 48 Faucets total – Box Width: 73"

Need a Custom Size ? Contact us.

Now anything can be your dispenser!

Chill Smart Inserts

- SS Beer Lines with shanks bolt in from front.
- Copper glycol lines with 3/8" barb fitting.
- Multiple Layers of Insulation.
- Large Cold Block to provide consistent cooling.
- Includes 304 grade SS Shanks and Faucets.
- Available in center, down and side outlets.
- Custom requests welcome.
- Can be used in Towers or Wall Mount Systems.



Specify tubing direction when ordering :

- Center Straight
- Center Down
- Side Straight

- Shanks included for upto 1/2" thick wall. Order longer shank for thicker walls.
- Specify wall thickness when ordering. (Difference in Shank Price will apply)
- Shanks setup at 3" apart. Custom distance available.

Item	Size
CS0141	4 Product With Shanks and Faucets
CS0161	6 Product With Shanks and Faucets
CS0181	8 Product With Shanks and Faucets
CS01101	10 Product With Shanks and Faucets
CS01121	12 Product With Shanks and Faucets

Pipe Wall Mount Towers



Brooklyn Wall Mount Towers : 3" Pipe

Air Cooled Chrome Contact	Air Cooled SS Contact	Glycol Ready Chrome Contact	Glycol Ready SS Contact	3" Pipe Wall Mount Polished SS Finish
CTW3P4	CTW3P4SS	CTW3P4-GL	CTW3P4SS-GL	4 Faucet – 23 1/2" wide
CTW3P5	CTW3P5SS	CTW3P5-GL	CTW3P5SS-GL	5 Faucet– 26 1/2" wide
CTW3P6	CTW3P6SS	CTW3P6-GL	CTW3P6SS-GL	6 Faucet– 29 1/2" wide
CTW3P8	CTW3P8SS	CTW3P8-GL	CTW3P8SS-GL	8 Faucet– 35 1/2" wide
CTW3P10	CTW3P10SS	CTW3P10-GL	CTW3P10SS-GL	10 Faucet– 41 1/2" wide
CTW3P12	CTW3P12SS	CTW3P12-GL	CTW3P12SS-GL	12 Faucet– 47 1/2" wide

Tacoma Wall Mount Towers : 4" Pipe, All SS304 contact

Air Cooled	Glycol Ready	4" Pipe Wall Mount Brushed SS Finish
CTWP6	CTWP6-GL	6 Faucet Glycol
CTWP8	CTWP8-GL	8 Faucet Glycol
CTWP10	CTWP10-GL	10 Faucet Glycol
CTWP12	CTWP12-GL	12 Faucet Glycol

More Wall mount tower options on next page.

Under Bar and Wall Mount Dispensers

Now Available in up to 24 faucets !
Call us for sizes greater than 12 faucets.



Under Bar Mount Dispensers

Item	Description
CUT2	Under Bar mount dispenser – 2 faucets
CUT2-GL	Under Bar mount dispenser – 2 faucets Glycol
CUT3	Under Bar mount dispenser – 3 faucets
CUT3-GL	Under Bar mount dispenser – 3 faucets Glycol
CUT4	Under Bar mount dispenser – 4 faucets
CUT4-GL	Under Bar mount dispenser – 4 faucets Glycol
CUT5	Under Bar mount dispenser – 5 faucets
CUT5-GL	Under Bar mount dispenser – 5 faucets Glycol
CUT6	Under Bar mount dispenser – 6 faucets
CUT6-GL	Under Bar mount dispenser – 6 faucets Glycol
CUT8	Under Bar mount dispenser – 8 faucets
CUT8-GL	Under Bar mount dispenser – 8 faucets Glycol
CUT10	Under Bar mount dispenser – 10 faucets
CUT10-GL	Under Bar mount dispenser – 10 faucets Glycol
CUT12	Under Bar mount dispenser – 12 faucets
CUT12-GL	Under Bar mount dispenser – 12 faucets Glycol

Wall Mount Dispensers

Item	Description
CWT2	Wall mount dispenser – 2 faucets
CWT2-GL	Wall mount dispenser – 2 faucets Glycol
CWT3	Wall mount dispenser – 3 faucets
CWT3-GL	Wall mount dispenser – 3 faucets Glycol
CWT4	Wall mount dispenser – 4 faucets
CWT4-GL	Wall mount dispenser – 4 faucets Glycol
CWT5	Wall mount dispenser – 5 faucets
CWT5-GL	Wall mount dispenser – 5 faucets Glycol
CWT6	Wall mount dispenser – 6 faucets
CWT6-GL	Wall mount dispenser – 6 faucets Glycol
CWT8	Wall mount dispenser – 8 faucets
CWT8-GL	Wall mount dispenser – 8 faucets Glycol
CWT10	Wall mount dispenser – 10 faucets
CWT10-GL	Wall mount dispenser – 10 faucets Glycol
CWT12	Wall mount dispenser – 12 faucets
CWT12-GL	Wall mount dispenser – 12 faucets Glycol

SS Drip Trays with Shank Holes



- Includes drain nipple.
- 14" tall. Holes punched 2" down from the top edge.
- Ask for the number of shank holes required.

6-1/2" Wide Tray

Item	Description
CDTB8	8" Wide – Up to 3 holes with 3" spacing.
CDTB15	15" Wide – Up to 5 holes with 3" spacing.
CDTB24	24" Wide – Up to 8 holes with 3" spacing.
CDTB30	30" Wide – Up to 10 holes with 3" spacing.
CDTB36	36" Wide – Up to 12 holes with 3" spacing.
CDTB48	48" Wide – Up to 15 holes with 3" spacing.
CDTB60	60" Wide – Up to 20 holes with 3" spacing.
CDTB76	76" Wide – Up to 25 holes with 3" spacing.

8" Wide Tray

Without Rinser	With Rinser	Description
CDTB15-8	CDTB15-8R	15" Wide – Up to 5 holes
CDTB24-8	CDTB24-8R	24" Wide – Up to 8 holes
CDTB30-8	CDTB30-8R	30" Wide – Up to 10 holes
CDTB36-8	CDTB36-8R	36" Wide – Up to 12 holes
CDTB48-8	CDTB48-8R	48" Wide – Up to 15 holes



RINSER CAN BE PLACED ON EITHER SIDE OF PAN

Tower possibilities are endless at Chill Passion

You supply the imagination! We will make it happen. Our towers are assembled in-house and we can create the perfect tower that will set your place apart from others.



Upright Slim Tower

Item	Description
C523	4" column tower - 3 faucets
CUST1	Upright Slim Tower – Single Faucet
CUST1SS	Upright Slim Tower – Single Faucet – All SS304
CUST1N	Upright Slim Tower – Single Faucet, Stout Faucet
CUST1NSS	Upright Slim Tower – Single Faucet, Stout Faucet – SS304

- 14.5" high.
- Faucet spout is 12.5" from counter.
- Thru Bar installation.
- 4" long installation shank.

Axis Tower

Item	Description
CTA515	Axis Tower – Chrome plated brass
CTA530	Axis Tower – Chrome plated brass



Column Towers – Air or Glycol Ready

Polished SS body tower with Chrome plated brass faucets and shanks



- 3” Diameter, Polished SS body.
- Chrome plated brass faucets and shanks.
- 1 and 2 faucet towers are 12” high.
- 3 faucet tower is 14-1/2” high.

2.5” Column, 10” high
Plated metal body

All Column towers include:

- Standard US faucets & black knobs
- All mounting hardware & gasket
- 3/16” ID x 5’ beer line

Air Cooled

Item	Description
CT21	1 Faucet 2.5” diameter - Air cooled
CT31	1 Faucet , Air cooled
CT32	2 Faucets, Air cooled
CT33	3 Faucets, Air cooled

Glycol Ready

Item	Description
CT21-GL	1 Faucet 2.5” diameter – Glycol ready
CT31-GL	1 Faucet, Glycol Ready
CT32-GL	2 Faucets , Glycol Ready
CT33-GL	3 Faucets, Glycol Ready

Polished SS body tower with All SS 304 contact



- 3” Diameter, Polished SS body.
- SS304 beer faucets and shanks.
- 1 and 2 faucet towers are 12” high.
- 3 faucet tower is 14-1/2” high.

Air Cooled

Item	Description
CT31SS	1 Faucet, Air Cooled
CT32SS	2 Faucets, Air Cooled
CT33SS	3 Faucets, Air Cooled

Glycol Ready

Item	Description
CT31SS-GL	1 Faucet, Glycol Ready
CT32SS-GL	2 Faucets, Glycol Ready
CT33SS-GL	3 Faucets, Glycol Ready

Variations on column towers!

All Column Towers can be made with SS Drop Lines , “No Spin” shanks, Wine Ready etc. Just ask for what you need.

PVD coated SS body tower



- 3” PVD coated SS body
- Polished brass beer faucets and shanks.
- 1,2 faucet towers: 12” high.
- 3 faucet tower : 14” high.

Polished brass faucets and shanks

Air Cooled

Item	Description
CT31B	1 Faucet, Air cooled
CT32B	2 Faucets, Air cooled
CT33B	3 Faucets, Air cooled

Glycol Ready

Item	Description
CT31B-GL	1 Faucet, Glycol Ready
CT32B-GL	2 Faucets, Glycol Ready
CT33B-GL	3 Faucets, Glycol Ready

All SS304 Contact PVD SS304 faucets and SS304 shanks

Air Cooled

Item	Description
CT31SSB	1 Faucet, Air cooled, SS304
CT32SSB	2 Faucets, Air cooled, SS304
CT33SSB	3 Faucets, Air cooled, SS304

Glycol Ready

Item	Description
CT31B-GL	1 Faucet, Glycol Ready, SS304
CT32B-GL	2 Faucets, Glycol Ready, SS304
CT33B-GL	3 Faucets, Glycol Ready, SS304

Column Towers – “No Spin” Technology

Polished SS body tower - No Spin Shanks with Chrome plated brass faucets and shanks



Item	Description
CT32-NS	2 Faucet, Air, No spin
CT33-NS	3 Faucets , Air, No spin
CT32-GL-NS	2 Faucets , Glycol Ready, No Spin
CT33-GL-NS	3 Faucets, Glycol Ready, No Spin

Polished SS body tower – No Spin Shanks All SS 304 contact

Item	Description
CT32SS-NS	1 Faucet, SS Contact, Air, No spin
CT33SS-NS	2 Faucets , SS Contact, Air, No spin
CT32SS-GL-NS	2 Faucets , SS Contact, Glycol Ready, No Spin
CT33SS-GL-NS	3 Faucets, SS Contact, Glycol Ready, No Spin

- 3” Diameter, Polished SS body.
- Chrome plated brass faucets and shanks.
- 2 faucet tower 1s 12” high.
- 3 faucet tower is 14-1/2” high.

- Specially designed Tower and Shank stops shank spinning.
- Eliminates possibility of kinks in the line.
- Improves durability of the tower.
- Less Service Calls.



4” Column Towers

Item	Description
CT43	4” Column Tower with 3 Faucets
CT43SS	4” Column Tower 3 Faucets , All SS304
CT44	4” Column Tower 4 Faucets
CT44SS	4” Column Tower 4 Faucets , All SS304

Add “-GL” for glycol ready towers.



Clamp On Towers

- Available in Single or Double Faucet
- Tray With or Without Drain

Item	Description
CCT1	Single Tap, Drip Tray No Drain
CCT2	Double Tap, Drip Tray No Drain
CCT1D	Single Tap, Drip Tray With Drain
CCT2D	Double Tap, Drip Tray With Drain



Tower Caps Mounting Gasket Mounting Screw

Item	Description
CT21.2	2.5” Tower Cap - Chrome
C507	3” Tower Cap – Chrome
C506	3” Tower Cap - Polished Brass / PVD
CT3.GSK	Mounting Gasket – 3” column tower
CT3.SCR	Mounting Screw - SS



CTE16:

CTE17



CTE18

3" Draft Beer Tower Extensions

Easily add on a line to single or double faucet towers.

- Includes required shanks.
- Includes screws and drill bit.

Item	Description
CTE16	Converts single faucet to double faucet
CTE17	Add a faucet to single or double faucet.
CTE18	Converts single faucet to triple faucet.

Wine, Coffee, Liquor Dispensing

- * Any tower can be made with Wine or Coffee Certified Parts.
- * Multiple Faucet Types available with wine and liquor towers
- * Contact us to inquire !

All towers on this page are listed without faucets. Select the desired faucet separately.



3" column Towers
Air Cooled. Glycol upon request
Includes 5' of BEV-SEAL Ultra Tubing

Item	Wine, Liquor, Coffee Faucets sold separately
CT31SS-W	1 Line – Polished SS
CT32SS-W	2 Lines – Polished SS
CT33SS-W	3 Lines – Polished SS
CT31BSS-W	1 Line – PVD Brass Look
CT32BSS-W	2 Lines - PVD Brass Look
CT33BSS-W	3 Lines - PVD Brass Look



Miami Towers
Glycol Ready
SS Lines

Item	Wine, Liquor, Coffee Faucets sold separately
CMMT1-W	1 Line
CMMT2-W	2 Lines
CMMT3-W	3 Lines
CMMT4-W	4 Lines



Slim Upright Towers
Air Cooled
Includes 5' of BEV-SEAL Ultra Tubing

Item	Wine, Liquor, Coffee Faucets sold separately
CUST1SS-W	Upright Slim Tower – Single Line

SS304 Parts for Wine, Coffee, Liquor Dispensing



Item Description	Page Number
SS304 Faucets	Page 16 ,17 and 18
SS304 Shanks	Page 21
Keg Couplers with S304 probe	Page 26
SS304 Tail Pieces and fittings	Page 23 and 24

For Nitro Coffee



CFS67



CFSW30



CFPX2W3
Available in
White, Black
and Burgundy

Faucet Selection Good for Wine, Coffee, Liquor, Water

Faucet Details on Page 17, 18, 19



CFS304



CFS310



CFS36



CFS37

Stainless Steel Drip Trays



- 5" or 6" Wide
- SS 304 construction

Many of the drip trays are now
Made in USA



Made in USA

Item	No Drain Drip Trays – 5" wide
CDT64	6" x 5" SS Drip Tray – no drain
CDT125	12" x 5" SS Drip Tray – no drain
C607	14" X 6" SS Drip Tray – no drain

Item	With Drain – 5" Wide
CDT125D	12" X 5" SS Drip tray with drain
CDT165D	16" X 5" SS Drip tray with drain
CDT205D	20" X 5" SS Drip tray with drain
CDT245D	24" X 5" SS Drip tray with drain
CDT305D	30" X 5" SS Drip tray with drain
CDT365D	36" X 5" SS Drip tray with drain



8" wide trays

Item	Description
CDT208D	20" X 8" SS Drip tray with drain
CDT248D	24" X 8" SS Drip tray with drain
CDT308D	30" X 8" SS Drip tray with drain
CDT368D	36" X 8" SS Drip tray with drain
CDT458D	45" X 8" SS Drip tray with drain
CDT508D	50" X 8" SS Drip tray with drain
CDT628D	62" X 8" SS Drip tray with drain
CDT768D	76" X 8" SS Drip tray with drain

Platform Drip Trays



Item	No Drain Drip Trays – 5" wide
CDTP_15X15	15" x 15" Platform SS Drip Tray – with drain
CDTPR_15X15	15" x 15" Platform SS Drip Tray – with Rinser and drain



More Drip trays on next page.

Need a size or configuration not shown ? Contact us

Glass Rinsers Drip Trays

- * Rinse away any impurities that might be in the glass.
- * Chill the glass utilizing cold water.
- * A wetted glass pours better.

New Improved Rinsers!



8" wide trays with Rinser



6.5" x 11" for side mounting

6.5" x 6.5"

Contact us for other sizes of drip trays.

- New design prevents sticking of rinser.
- Multiple splay holes.
- Outer threads are 1/2" Pipe thread to fit water connection.
- 3/8" removable barb fitting provided.
- 1/4" pipe thread when barb fitting is removed.



CDTR2
Rinsers assembly with wings
Width 4-1/4"



CDTR3
Rinsers assembly with disk
Width 4-1/4"

Item	Description
CDT308R	30"x8" SS Drip tray with rinser and drain
CDT368R	36"x8" SS Drip tray with rinser and drain
CDT458R	45"x8" SS Drip tray with rinser and drain
CDT66RF	6.5" x 6.5" Rinser Drip tray with side mounting flange
CDT66R	6.5" x 6.5" Rinser Drip tray
CDTR2	Rinsers Assembly with wings
CDTR3	Rinsers Assembly with disk

Drip Tray with Cut Out

- Fits 3" Column
- Cut out diameter : 5" x 2"
- Brushed Stainless Steel Finish
- Size: 12" L x 7" W x 3/4" H



Item	Description
CDTC127	Cut out drip tray - No Drain
CDTC127D	Cut out drip tray - With Drain

Flush Mount Drip Tray – with drain

- Fits flush into the counter.
- 12" x 5" , 3/4" deep.
- 1/2" flange (additional all around).

Item	Description
CDT125F	12" X 5" Flush Mount

Stainless Steel Wall Mount Drip Trays



Wall Mount Drip Trays - No Drain

Item	Description
CDTW64	6" x 5" SS Drip tray with perforated gill
CDTW106	10" x 6" SS Drip tray wall mount
CDTW126	12" x 6" SS Drip tray wall mount
CDTW146	14" x 6" SS Drip tray wall mount

Wall Mount Drip Trays – With Drain

Item	Description
CDTW64D	6 x 5" SS Drip tray wall mount, with drain
CDTW106D	10" x 6" SS Drip tray wall mount, with drain



Drain Assembly

Item	Description
C954	2" long x 1/2" NPT
C955	4" long x 1/2" NPT

- * Brass Drain Assembly replacement for any drip tray.
- * Comes complete with locknut and washer.



Item	Description
C301S.1	Black Rubber Washer

Standard Drain Assembly



Item	Description
C959	6" long
C141	8" long

Drain Nipple and Nut



Item	Description
C610	Use with drain – thread 5/8"x18

Sani-Clean AM™ Drain Tubing



Item	Description
CPHD1234	Accuflex Sani-Clean AM™ Drain Tubing 1/2 x 3/4

Brass Beer Faucets



CFP1 Chrome with brass lever



CFP2 Chrome with SS lever



CFP5 Polished Brass with brass lever



CFP6 Polished Brass with SS lever

Item	Description
CFP1	Chrome with brass lever
CFP2	Chrome with SS lever

Item	Description
CFP5	Polished brass with brass lever
CFP6	Polished brass with SS lever

Stainless Steel Faucets

SS304: Good for Wine , Beer Cider , Coffee, Tea etc.



CFS304 - Stainless Steel faucet SS 304



CFS304 – PVD Gold faucet SS 304



CFS304 – PVD Black faucet SS 304



CFS304 – PVD Rose Gold/ Copper faucet SS 304

Item	Description
CFS304	Stainless Steel faucet - All Contact : SS 304
CFS304-GLD	PVD Gold/ Brass SS 304 faucet

Item	Description
CFS304-BLK	PVD Black SS 304 faucet
CFS304-RSG	PVD Rose Gold/ Copper SS 304 faucet



Self Closing Faucet:
CFP7 : CP Brass
CFS7 : SS304



C183: Creamer
Faucet



Perlick Forward
Sealing Faucet

Item	Description
CFP7	Self closing faucet Chrome with brass lever
CFS7	Self Closing Faucet - Stainless Steel
C183	Creamer faucet Chrome plated Brass
CPP630PC	Perlick Forward Sealing Faucet – Chrome Plated Brass
CPP630SS	Stainless Steel Perlick Beer faucet (SS304)
CPP680SS	SS Perlick Faucet with Creamer



CFS310



CFS37



CFSW30
Ball Faucet

SS304 Faucet with extended spout for Beer or Wine

Item	Description
CFS310	SS 304 Faucet Extended spout
CFS37	PVD Faucet SS304 with Extended spout
CFPW30	Ball Faucet for Wine

Faucet Parts

CFP1.40
Friction washer

CFP1.50
Ring- friction

CFP1.60
Shaft Seat washer



Back washer- CFP1.34



Brass lever – CFP1.10
SS Lever – CFS304.10



Chrome- CFP1.20
SS - CFS304.20



CPE27
Spout Extension
Can fit all of our
standard faucets.

Item	Description
CFP1.10	Brass Lever
CFS304.10	Stainless Steel Lever
CFP1.20	Shaft Assembly (CP Brass)
CFS304.20	Faucet Shaft Assembly-SS304
CFP1.34	Faucet body - back Gasket
CFP1.40	Friction washer
CFP1.50	Ring – Friction
CFP1.60	Shaft Seat Washer
CPE27	Faucet Spout Extension

CMB Standard Faucets

CMBecker
INTERNATIONAL, LLC

CMB Wine Faucets



CFPX2: Plastic
Body, Creamer



CFPV3S: SS304
Creamer
Forward Sealing

Forward
Sealing



CFPV2G: SS304
Creamer
Forward Sealing
Extended SS Nozzle

Forward
Sealing



Item	Description
CFPX2	CM Becker Plastic Faucet with Creamer
CFPV3S	CM Becker SS304 Forward Seal Faucet with Creamer
CFPV2G	CM Becker SS304 Forward Seal Faucet ,Creamer, Curved SS Nozzle
CFPX2W1	Wine Faucet - Black
CFPX2W2	Wine Faucet - White
CFPX2W3	Wine Faucet - Burgundy

CMB Forward Seal Faucets feature encapsulated piston chamber for a smooth and no leak forward sealing operation.



CPP650SS / CPP690SS

- SS Perlick Flow Control Faucet.
- Fits standard American shanks.



CFP10

European Flow Control Faucet and shank set.

Flow Control Faucets

Item	Description
CPP650SS	Perlick Flow Control Faucet – SS 304
CPP690SS	Perlick SS Flow Control Faucet with Creamer
CFP10	European Flow Control Faucet and shank set.



CF4200

Inline flow control valve.

Order nipple and nut combo separate

Item	Description
CF4200	Inline flow control valve
CF4204	4mm Nipple and Nut combo
CF4206	6 mm Nipple and Nut combo
CF4207	7mm Nipple and Nut combo
CF4210	10 mm Nipple and Nut combo

Stout Faucets



Item	Description
CFP67	Stout Faucet – Chrome plated brass
CFS67	Stout Faucet – All SS304 Contact
CFP68	Stout Faucet – Polished Brass
CFS68	Stout Faucet – PVD Stainless Steel

Stout faucet parts

Ref#	Item	Description
1	CFP67.01	Spout – SS304
2	CFP67.16	Regulation Core
3	CFP67.15	Jet Disk (Restrictor Plate)
4	CFP67.14	O-Ring 10x2 (For Nozzle)
6	CFP87.06	O-Ring for Piston 6 mm
7	CFP87.07	O-Ring for Piston 7 mm
12	CFP67.05	O-Ring 17x25 (Sliding cap)
13	CFP67.04	Sliding Cap
14.01	CFP67.05	Cam - Chrome

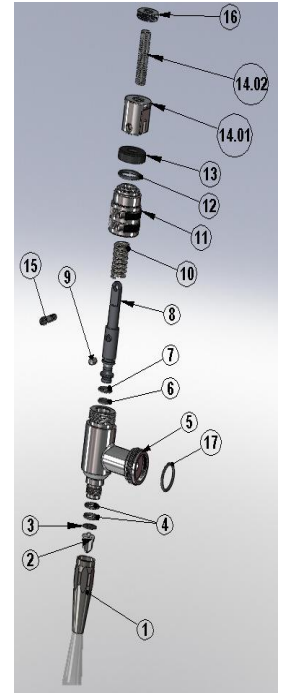

CMB Stout Faucet

German Engineered and US Made Nitro Faucet with SS Nozzle and high grade plastic and SS parts. This faucet, like other CMB V3 series faucets utilizes a forward seal piston .

Item	Description
CFPV3	CMB Stout Faucet – Chrome plated brass



Wrap Around Faucet Lock

- Tamper-proof and extremely easy to install and remove.
- Lock features brass tumbler, hardened steel locking hasp and locks that are keyed alike.
- Limits beer shrinkage at commercial premises.
- Eliminates underage access to your draft beer setup.

Item	Description
CFL39	Faucet Lock for Standard Faucets
CFL40	Faucet Lock for Perlick 630 Faucets

Faucet Plug



- Seal a shank when the faucet is removed. Perfect for draft beer trailers when securing for storage or travel.
- Fits all beer and wine shanks. Same threads as faucet.

Item	Description
C130	Faucet Plug



Faucet Spout Plug

A spout plug is an economical solution for controlling fruit flies, yeast and bacteria buildup when the faucet is not in use.

Item	Description
C182	Faucet Spout Plug



Faucet Hygiene Plug

- Stainless Steel core – Will not rust.
- Wider Bristles to clean and hold better.
- Stepped design to fit various kinds of faucets.

- Keeps unwanted pests out.
- Cleans the faucet spout each time brush is inserted and removed.
- Fits various faucet spouts including American standard and Perlick.

Item	Description
CB45	Faucet Hygiene Plug



Jug - Growler filler

Perfect for filling jugs and growlers. Allows beer to be filled from bottom up, generating less foam.
 -304 Grade SS Nozzle
 - 12" of 1/4" ID hose (can be customized)

All Growler fillers have Stainless Steel nozzles.
 Use with SS or Chrome faucets



Item	Description
CP78	SS Jug / Growler filler - Fits standard American faucets
CP63	SS Jug / Growler filler - Fits Perlick 630 and 650 series faucets

CP78– For standard US faucets

CP63 – Fits Perlick faucets(600 series)



C186



CP188



CPE93.8



C185SS



CP884



CPC300.6

Item	Description
C186	Plastic knob -No Brass insert – 2.5" long
CP188	Plastic knob Round Top - With Brass insert – 2.5" long
CPE93.8	Round Black knob
C185SS	Stainless Steel knob- 2.5" long
C190	Chrome plated brass long handle – 6" long
CP884	Brass insert for wood handles
CPC300.60	Label holder round
C129	Chrome plated brass
C829	Polished brass



C129 – Chrome plated brass
 C829 – Polished brass

Faucet Handle Angler
 (Tap marker handle tilter)

Ferrules



- * Fits standard beer tap and handle
- * Top Thread: 5/16" BSW
- * Bottom Thread: 3/8" UNC
- * Dimensions: 3/4"W x 1"H

Tap Handle Hardware

Item	Description
CP43	Standard Chrome ferrule
CP44	Standard Brass Color ferrule
C696	Tap handle bolt

Tap Handle Bolt



- Zinc plated steel
- Dimension: 1.5" L

Beer Faucet Shank Assembly – Chrome plated Brass

Chrome plated brass – 1/4" bore

Item	Description
C301	2 -1/8" long
C302	3 -1/8" long
C303	4 -1/8" long
C304	5 -1/8" long
C305	6 -1/8" long
C306	8 -1/8" long
CPC10301	10-1/8" long
CPC12301	12-1/8" long
CPC14301	14-1/8" long

Chrome plated brass – 3/16" bore

Item	Description
C312	2 -1/8" long
C313	3 -1/8" long
C314	4 -1/8" long
C315	5 -1/8" long
C316	6 -1/8" long



Add SS flange to any shank for only \$1.00. (Add part C127 to your order)

Now Available in up to 14" long

Nipple Shank Assembly – Chrome plated Brass

Chrome plated brass nipple shank – 1/4" bore

Item	Description
C318	2 -3/4" long
C319	3 -1/2" long
C320	4 -1/2" long
C327	5 -1/2" long

Chrome plated brass nipple shank – 3/16" bore

Item	Description
C322	2 -1/2" long
C323	3 -1/2" long
C324	4 -1/2" long
C326	5 -1/2" long



Length is for shank only. Nipple adds 1/2"

Nipple Shank Assembly 3/16" - Fixed sleeve with SS flange CP Brass or SS304



Shank length – 1.75" (nipple adds 1/2")

- Fixed sleeve
- SS flange included
- Forged brass locking nut
- Perfect for Box towers or any other flat wall.

Item	Description
C300	CP Brass Shank assembly with SS flange
C300A	CP Brass Shank only – no parts
CSS300	SS304 Shank Assembly with SS flange

Stainless Steel Shanks

304 Grade Stainless Steel

SS 304 contact.
Good for
Wine or Beer

SS304 shanks - 1/4" bore

Item	Description
CSS210	1-3/4" long
CSS212	2" long
CSS251	2-3/4" Fixed Sleeve
CSS213	3-1/8" long
CSS214	4-1/8" long
CSS234	5-1/8" long
CSS235	6-1/8" long
CSS108	8-1/8" long
CSS110	10-1/8" long
CSS112	12-1/8" long

Upto 12" long SS shank available



Add SS flange to any shank for only \$1.00. (Add part C127 to your order)

SS304 shanks - With Nipple (3/16" ID, 1/4" Barb)

Item	Description
CSS300	1-3/4" long, fixed sleeve, SS flange
CSS322	2-1/2" long, fixed sleeve
CSS253	3-1/8" long, fixed sleeve



Nipple adds 1/2"

Column and Elbow Shanks

Item	Description
CPC28	Plated Brass column shank with elbow . 1-7/8" x 3/16" ID
CPC29	Polished Brass column shank with elbow . 1-7/8" x 3/16"ID
CPC50	Plated Brass column shank - straight nipple. 1-7/8" x 3/16"ID
CPC58	Plated Brass shank with elbow (black plastic flange). 1-7/8" x 3/16"ID



CPC28, CSS31

CPC29, CSS29

CPC50, CSS50

CPC58, CSS58

Item	Description
CSS31	SS column shank with elbow. 1-7/8" x 3/16" ID
CSS29	SS column shank -Brass Look, elbow. 1-7/8" x 3/16" ID
CSS50	SS column shank - straight nipple. 1-7/8" x 3/16" ID
CSS58	SS shank with elbow (black plastic flange). 1-7/8" x 3/16" ID

SS 304 contact.
Good for
Wine or Beer

Compression Shank Assembly



Item	Description
C307	Compression Shank Assembly
CSS307	SS304 Compression Shank Assembly
C308	Shank Grommet (pack of 100)

24" Wall Shank Assembly

Includes locking flange

SS304

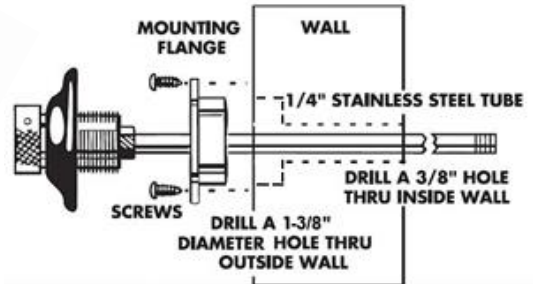

Item	Description
CSS125	24" Wall shank assembly –SS304 (includes locking flange)
C126	Locking flange

Shank parts



CPC300.11

CPC300.12

C119

C419



CPC300.13



C127 – SS flange



CPC300.14



CPC28.2



CPC28.3



CPC28.4

Item	Description
CPC300.11	Shank Snap Ring
CPC300.12	Shank Sleeve
C119	Coupling Nut
C419	Polished Brass coupling nut
CPC300.13	Plastic Flange
C127	SS flange
CPC300.14	Lock Nut – flanged
CPC28.2	Lock nut for column shank
CPC28.3	Curved plastic flange –3” diameter
CPC28.4	Metal grooved lock washer

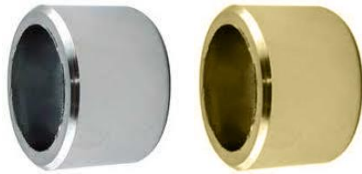

CPC300.10 - 1” shank extension Chrome
CPC300.20 - 1” Polished brass extension



CPC300.40 – 5/8” Tapered shank extension , chrome.
(Flat on both sides, no cut out).



Column flange, Chrome or Polished Brass

Item	Description
CPC300.10	1” shank extension – Chrome
CPC300.30	3/4” shank extension – Chrome
CPC300.20	1” shank extension – Polished Brass
CPC300.40	5/8” Conical shank extension , chrome.

Item	Chrome Flanges
CPC28.1	For 3” column shank
CPC48.1	For 4” column shank
CPC78.1	For 7” column shank

Item	Polished Brass Flanges
CPC29.1	For 3” column shank
CPC49.1	For 4” column shank
CPC79.1	For 7” column shank

Cold block

Each set includes two pieces.



Item	Description
C228	Cold block

Front Side Lock Nut - Chrome

New !

Allows you to tighten screw-in shanks from the front side using standard faucet wrench.

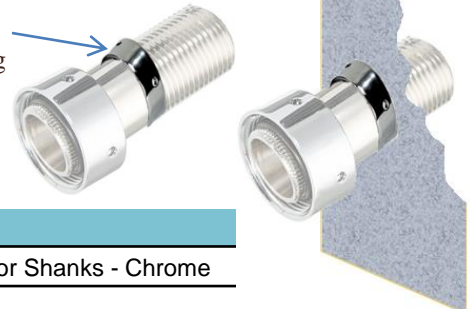

Item	Description
CPC300.05	Front Side Lock Nut for Shanks - Chrome

Accuflex Vinyl Hose – Bevlex Series 200

Item	Description	Clamp size
CPHC316	Clear PVC Hose 3/16" ID X 7/16" OD	12.3
CPHC14	Clear PVC Hose 1/4" ID X 1/2" OD	13.3
CPHC516	Clear PVC Hose 5/16" ID x 9/16" OD - sold in 100' rolls	15.7
CPHC38	Clear PVC Hose 3/8" X 5/8" – sold in 100' rolls	17.0
CPHB316	Black PVC Hose 3/16" ID X 7/16" OD	12.3
CPHR516	Red PVC Hose for air line 5/16" ID X 9/16" OD	15.7

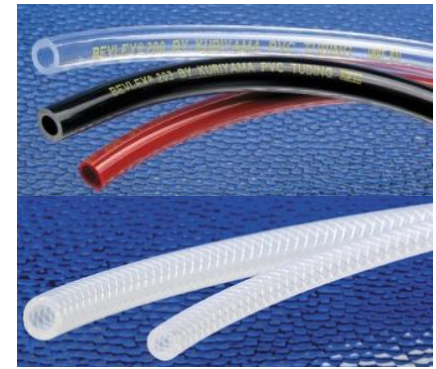

Accuflex Braided Hose – CLEARBRAID Series K3150

CPHCB316	Clear Braided Hose 3/16" x 5/8" – sold in 100' rolls	12.3
CPHCB14	Clear Braided Hose 1/4" x 7/16" – sold in 100' rolls	13.3
CPHCB516	Clear Braided Hose 5/16" x 7/32" – sold in 100' rolls	14.0
CPHCB38	Clear Braided Hose 3/8" x 19/32" – sold in 100' rolls	15.7

Accuflex Poly Tubing – Non Barrier , 222 series

Item	Description	Clamp size
CPH222-08620-00	3/8" Non Barrier Poly Tubing (Sold in 500' rolls)	13.3
CPH222-10620-00	1/2" Non Barrier Poly Tubing (Sold in 500' rolls)	16.2

Accuflex Poly Tubing – Barrier, 235 series

CPH235-05620-00	3/16" Poly Barrier Tubing White (Sold in 500' rolls)	10.5
CPH235-06620-00	1/4" Poly Barrier Tubing White (Sold in 500' rolls)	10.5
CPH235-07620-00	5/16" Poly Barrier Tubing White (Sold in 500' rolls)	12.3
CPH235-08620-00	3/8" Poly Barrier Tubing White (Sold in 500' rolls)	13.3



Tail pieces



Plated Brass

Item	Barb Size	Fits Vinyl Hose ID
CFT1	1/4" barb	3/16"
CFT2	5/16" barb	1/4"
CFT3	3/8" barb	5/16"
CFT4	1/2" barb	3/8"
CFT5	5/8" barb	1/2"

For Poly tubing, use one size smaller

Stainless Steel (304 grade)

Item	Barb size	Fits Vinyl or Poly. Hose ID
CFTSS1	3/16" barb	3/16"
CFTSS2	1/4" barb	1/4"
CFTSS3	5/16" barb	5/16"
CFTSS4	3/8" barb	3/8"



See page 39 for these and other homebrew parts.



Beer Hex Nut *Brass or SS Wing Nut Beer Washer

Item	Description
C181	Beer Nut
C181SS	SS304 Beer Hex Nut
C193	Wing Nut
C116	Beer Washer

SS Stepless Clamps



Item	Nominal Size (mm)
CPSC105	8.8 - 10.5
CPSC119	9.8 - 11.9
CPSC123	9.8 - 12.3
CPSC133	10.8 - 13.3
CPSC140	11.5 - 14.0
CPSC157	13.2 - 15.7
CPSC162	13.7 - 16.2
CPSC170	14.5 - 17.0
CPSC185	15.3 - 18.5
CPSC198	16.6 - 19.8
CPSC210	18.2 - 21

SS Worm Clamp



Item	Range
CPWC25	1/4 - 5/8"
CPWC35	3/8 - 3/4"



C398



CP398-38-STR



CP398-38XMBT



CP271-FMBTXMBT



CP398-MBTXMBT



CPY38B

Item	Description
C398	SS Wall bracket 3/8" x 3/8"
CP398-38-STR	SS Wall bracket 3/8 Barb Straight
CP398-38XMBT	SS Wall bracket 3/8 Barb X MBT
CP398-MBTXMBT	SS Wall bracket MBT X MBT
CP271-FMBTXMBT	SS Wall bracket MBT X MBT Forged
CPY38B	SS Y 3/8 Barb
CP137SS	SS Beer "Y" Fitting
CP133-3WAY	SS Beer Line wall bracket - 3 Way

Item	Description
C270	SS Beer Shutoff Valve MBT X FBT Swivel
C76MBT	SS Beer Shut-Off MBT X FBT
CP276	SS Beer Switch



CPI137SS



CPI133-3WAY



C270 - swivel Beer shutoff Valve



CP276 Beer Switch



C76MBT Beer shutoff Valve

Stainless Steel "T"

Item	Description
CF134	1/4" Barb
CF434	5/16" Barb
CF310	3/8" Barb
CF311	1/2" Barb
CF526	1/4"(1&2)X3/8"(3) Barb
CF527	3/8"(1&2)X1/4"(3) Barb

Stainless Steel Splicers

Item	Description
CF036	3/16" X 3/16" Barb
CF401	1/4" X 1/4" Barb
CF402	1/4" X 5/16" Barb
CF405	5/16" x 5/16" Barb
CF408	5/16" x 3/8" Barb
CF390	3/8" X 3/8" Barb
CF394	3/8" X 1/4" Barb
CF581	1/2"X1/2" Barb
CF723	3/8"X1/2" Barb

Stainless Steel Cross

Item	Description
CF564	1/4" Barb
CF565	3/8" Barb

Stainless Steel Elbow Tail Piece

Item	Description
CF067	3/16" Barb
CF068	1/4" Barb
CF066	5/16" Barb
CF069	3/8" Barb
CF070	1/2" Barb

Stainless Steel U bend

Item	Description
CF253	1/4" Barb
CF254	3/8" Barb
CF255	1/2" Barb
CF336	3 Ports - 1/4" Barbs (All)
CF338	3 Ports - 3/8" Barbs (All)

Stainless Steel Elbow

Item	Description
CF023	1/4" Barb
CF031	3/8" Barb
CF014	1/2" Barb

Plugs

Item	Description
CF119	SS - 1/4" Barb
CF120	SS - 3/8" Barb
CF121	SS - 1/2" Barb
CF124	Plastic -1/4"x1/2"x3/8" barbs

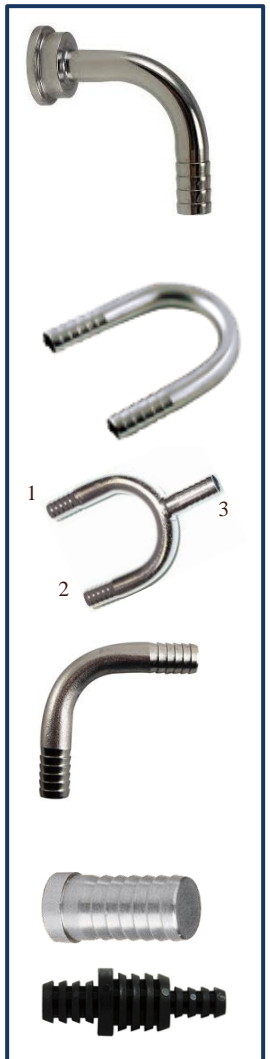

Can't find a fitting or a size ? Give us a call.



Clamp Crimper (full face or side jaw)



Hose / Pipe Cutter

Item	Description
CFT10	Clamp Crimper - Full Face
CFT11	Clamp Crimper - Side Jaw
CFT12	Hose / Pipe cutter (Spring Loaded)

Wrenches



CFT87



CFT23



CFT60 - CO2 wrench

Item	Description
CFT87	Faucet Wrench
CFT23	Faucet and Hex Nut Wrench
CFT60	CO2 Wrench - offset

Tube Sizing Rod



Item	Description
C200	Tube sizing rod

John Guest Push In Fittings

New !

Contact us for any other push in fittings and additional sizes



Item	Description
PI0306S	John Guest Quick Fit Elbow - 3/16"
PI0308S	John Guest Quick Fit Elbow - 1/4"
PM0308S	John Guest Quick Fit Elbow - 5/16"
PI0312S	John Guest Quick Fit Elbow - 3/8"
PI211208S	John Guest Quick Fit Elbow - 3/8" x 1/4"



Item	Description
PP0408W	John Guest Union Connector - 1/4"
PP0412W	John Guest Union Connector - 3/8"
PI201208S	John Guest Reducing Union - 3/8" x 1/4"
PI201210S	John Guest Reducing Union - 3/8" x 5/16"



Item	Description
PI451214FS	BSP Adapter - Female Connector 3/8 x 1/2" BSPP (Flat)

Keg Couplers



D System Keg Coupler
US Sankey

S System Keg Coupler
European Sankey

Item	Description
CK701D	D System Nickel plated brass probe
CK703D	D System Stainless Steel probe (SS304)
CK801D	D System, SS Body, Nickel plated brass probe
CK803D	D System, SS Body, Stainless Steel probe (SS304)
CK705S	S System Nickel plated brass probe
CK706S	S System Stainless Steel probe

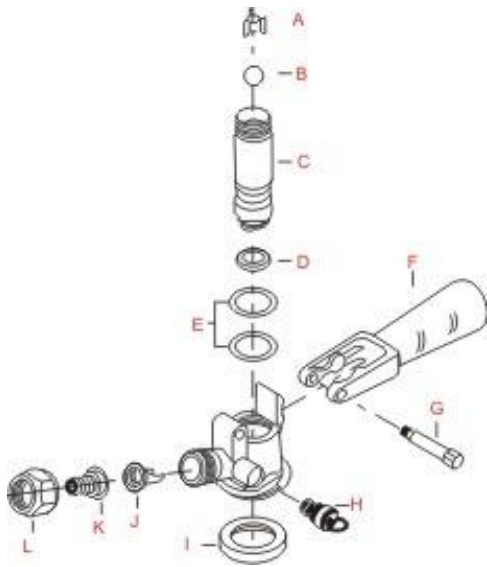

Ref#	Item	Description
A	CK701.1	Check Ball Retainer
B	CK701.2	Check Ball
D	CK701D.4	Keg Probe Seal – D Coupler
D	CK701S.4	Keg Probe Seal – S Coupler
E	CK701.5	O Ring
F	CK701.6	Black Handle with Cap
I	CK701.9	Sankey Tap bottom seal
J	CK701.10	Check Valve
K	CK701.11	Hose nipple (5/16")
H	CPG418	Pressure Relief valve (See page 27)

- 90 degree angle.
- Thread: 7/8" – 14 (5/8" BSP)
- Includes washer

Keg Coupler Elbow

Item	Description
C601	Keg Coupler Elbow



CK720A: A System Keg coupler
German Slider



CK721G: G System Keg coupler



CK722U: U System Keg coupler

Item	Description
CK720A	Type A - Brass body with SS probe, black lever, PRV
CK721G	Type G- Brass body with SS probe, black lever, PRV
CK722U	Type U- Brass body with SS probe, black lever, PRV

TAPRITE Primary CO2 Regulators



CGR261: 5/16" Barb shutoff w/check
CGR262: MFL shutoff w/check 60lb, 2000lb



CGR263
60lb, 2000lb



CGR264
60lb, 2000lb

Can't find a configuration you need in primary or secondary regulators? Just ask and we can build almost any configuration possible.

Item	Description	Gauges
CGR261	5/16" barb shutoff /w check	60 lb.,2000 lb.
CGR262	MFL shutoff /w check	60 lb.,2000 lb.
CGR263	5/16" barb shutoffs w/ check (2 way)	60 lb.,2000 lb.
CGR264	2 way, 2 pressure, 5/16" barb shutoffs w/ check	60 lb.,2000 lb.



Bev Rite Primary CO2 Regulators

Item	Description	Gauges
CGR561	5/16" barb shutoff /w check	60 lb.,2000 lb.
CGR562	MFL shutoff /w check	60 lb.,2000 lb.
CGR563	5/16" barb shutoffs w/ check (2 way)	60 lb.,2000 lb.
CGR564	2 way, 2 pressure, 5/16" barb shutoffs w/ check	60 lb.,2000 lb.

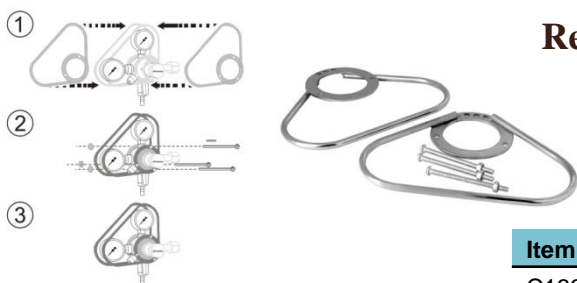

Regulator Gauge Cage

CR13 : Works with Taprite, Bevrite, Cornelius and Norgren regulators

Item	Description
C133	Regulator Gauge Cage
CR13	Regulator Gauge Cage



C133 : Works with Micro Matic and NADS regulators.



McDantim Blenders Trumix®



Trumix Gas Blenders

Built in adjustable secondary regulators

- Specify Needed Blend.
- Specify Size of Fittings.

Item	Description
MB100	Trumix Single
MB200	Trumix Double
MB300	Trumix Triple

TAP RITE Secondary and Nitrogen Regulators



CGR271
60lb, plugged

CGR272
60lb, pass thru

CGR282
60lb, 2 way

...up to 6 ganged regulators

Item	Description	Gauges
CGR271	Secondary , plugged,	60 lb.
CGR272	Secondary, pass thru	60 lb
CGR282	Secondary, 2 way ganged	60 lb
CGR283	Secondary, 3 way ganged	60 lb
CGR284	Secondary, 4 way ganged	60 lb
CGR285	Secondary, 5 way ganged	60 lb
CGR286	Secondary, 6 way ganged	60 lb
CGR252HN	Nitrogen High Pressure	60 lb, 3000 lb



CGR252HN
High Pressure
Nitrogen



Bev Rite Secondary Beer Regulators

Item	Description	Gauges
CGR571	Secondary , plugged,	60 lb.
CGR572	Secondary, pass thru	60 lb
CGR582	Secondary, 2 way ganged	60 lb
CGR583	Secondary, 3 way ganged	60 lb
CGR584	Secondary, 4 way ganged	60 lb
CGR585	Secondary, 5 way ganged	60 lb
CGR586	Secondary, 6 way ganged	60 lb
CGR252LN	Nitrogen High Pressure	60 lb, 3000 lb
CGR552HN	Nitrogen High Pressure	120 lb, 3000 lb



Replacement Gauges

Item	Description
CGRP10	Low pressure Gauge RHT
CGRP20	High pressure Gauge 0 - 2000 LHT
CGRP30L	High Pressure Gauge 0 - 3000 LHT
CGRP30R	High Pressure Gauge 0 - 3000 RHT
CPG008	CO2 Washer - Fiber
CPG009	CO2 Washer - Nylon

We can build any configuration you need. Contact us !

With 8' Beer and Gas Line

Choose Between Bev Rite or Tap Rite Regulators.

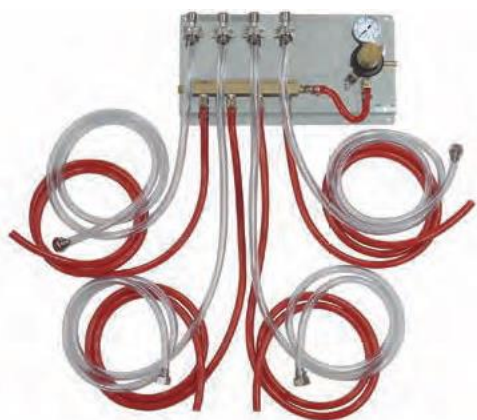

One Regulator with Manifold

Bev Rite Regulators	Tap Rite Regulators	Description
CGRK5102	CGRK102	2 Outlet, 1 Regulator
CGRK5103	CGRK103	3 Outlet, 1 Regulator
CGRK5104	CGRK104	4 Outlet, 1 Regulator
CGRK5105	CGRK105	5 Outlet, 1 Regulator
CGRK5106	CGRK106	6 Outlet, 1 Regulator

One Regulator with Manifold and FOBs

Bev Rite Regulators	Tap Rite Regulators	Description
CGRK5502	CGRK502	2 Outlet, 1 Regulator, Fobs
CGRK5503	CGRK503	3 Outlet, 1 Regulator, Fobs
CGRK5504	CGRK504	4 Outlet, 1 Regulator, Fobs
CGRK5505	CGRK505	5 Outlet, 1 Regulator, Fobs



Multi Regulator with Wall Brackets

Bev Rite Regulators	Tap Rite Regulators	Description
CGRK5202	CGRK202	2 Outlet Multi Regulator
CGRK5203	CGRK203	3 Outlet Multi Regulator
CGRK5204	CGRK204	4 Outlet Multi Regulator

Multi Regulator with FOBs

Bev Rite Regulator	Tap Rite Regulator	Description
CGRK5302	CGRK302	2 Outlet Multi Regulator, FOBs
CGRK5303	CGRK303	3 Outlet Multi Regulator, FOBs
CGRK5304	CGRK304	4 Outlet Multi Regulator, FOBs



Panels with Pumps and FOBs

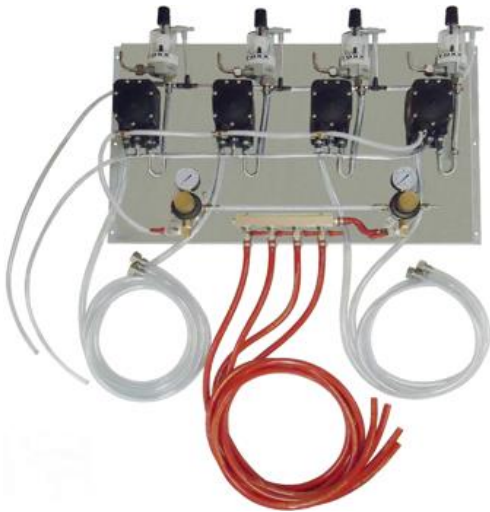

Bev Rite Regulators	Tap Rite Regulators	Description
CGRK5402	CGRK402	2 Outlet , with Pumps and FOBs
CGRK5403	CGRK403	3 Outlet , with Pumps and FOBs
CGRK5404	CGRK404	4 Outlet , with Pumps and FOBs

Blank Mounting Panels

Item	Description
CRMP118	Size 11" x 8.5"
CRMP1212	Size 12" x 12"
CRMP1216	Size 12" x 16"
CRMP1224	Size 12" x 24"



Air Distributors

We can assemble various configurations and sizes in-house. Just ask for what you need.

Item	Description
5/16" Barb Inlet , 5/16" Barb Outlets shutoff (With check Valve):	
CPG222	2 Way Air Distributor 5/16" barb shutoffs with check valve
CPG223	3 Way Air Distributor 5/16" barb shutoffs with check valve
CPG224	4 Way Air Distributor 5/16" barb shutoffs with check valve
CPG225	5 Way Air Distributor 5/16" barb shutoffs with check valve
CPG226	6 Way Air Distributor 5/16" barb shutoffs with check valve
CPG228	8 Way Air Distributor 5/16" barb shutoffs with check valve
3/8" Barb Inlet , 3/8" Barb Outlets shutoff (With check Valve):	
CPG252	2 Way Air Distributor 3/8" barb shutoffs with check valve
CPG253	3 Way Air Distributor 3/8" barb shutoffs with check valve
CPG254	4 Way Air Distributor 3/8" barb shutoffs with check valve
1/4" Barb Inlet , 1/4 Barb Outlets shutoff (With check Valve) :	
CPG232	2 Way Air Distributor 1/4" barb shutoffs with check valve
CPG233	3 Way Air Distributor 1/4" barb shutoffs with check valve
CPG234	4 Way Air Distributor 1/4" barb shutoffs with check valve
1/4" MFL Inlet , 1/4 MFL Outlets shutoff (With check Valve):	
CPG242	2 Way Air Distributor 1/4" MFL shutoffs with check valve
CPG243	3 Way Air Distributor 1/4" MFL shutoffs with check valve
CPG244	4 Way Air Distributor 1/4" MFL shutoffs with check valve

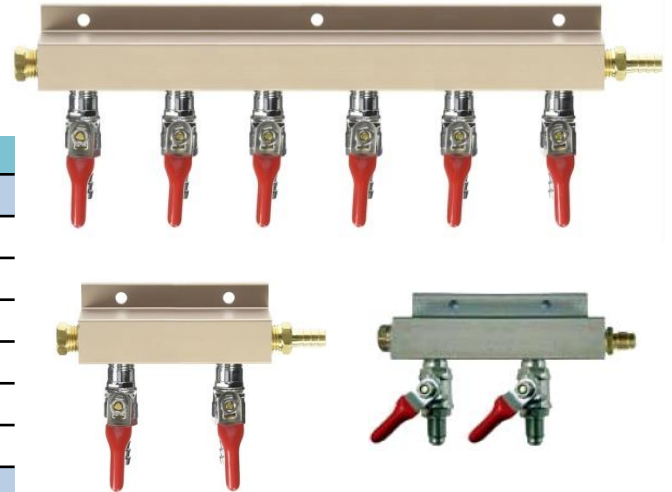

Now also available with relief valve!



See Part# CPG418 on Page 27. We can put it on for you at no extra cost. Just ask.

Manual Changeover Valve



CPG415: 1/4" Female x 1/4" Male x 1/4" Female.



CPG416: All 1/4" MFL

Item	Description
CPG415	Manual Changeover Valve
CPG416	Manual Changeover Valve - All MFL

Regulator Adapters



C295 – Nitrogen regulator to CO2 Tank adapter



C296 – CO2 regulator to Nitrogen tank adapter

Item	Description
C295	Adapt Nitrogen Regulator on CO2 Tank
C296	Adapt CO2 Regulator on Nitrogen Tank

Shutoff Valves and Parts



CPG221, CPG231, CPG251



CPG241



CPG251-NC



CPG271, CPG272



CPG273

Item	Description
CPG221	Gas shutoff valve – 5/16" barb with check valve
CPG221-NC	Gas shutoff valve – 5/16" barb – No check
CPG231	Gas shutoff valve – 1/4" barb with check valve
CPG241	Gas shutoff valve – 1/4" MFL with check valve
CPG251	Gas shutoff valve – 3/8" barb with check valve
CPG251-NC	Heavy duty gas shutoff valve, 3/8" barb – No check
CPG271	Plastic inline shutoff valve 3/8" barb
CPG272	Plastic inline shutoff valve 1/4" barb
CPG273	Chrome plated brass inline shutoff 1/4" barb



CPG001, CPG002



CPG002



CPG003



CPG410



CPG006



CPG411 (RHT)
CPG412 (LHT)



CPG413



CPG415



CPG418

Item	Description
CPG001	Hose Stem - 1/4 thread x 5/16" barb
CPG002	Hose Stem - 1/4 thread x 1/4" barb
CPG003	Hose Stem - 1/4 thread x 1/4" MFL
CPG006	1/4" NPT Plug, Hex Head
CPG410	1/4" NPT Hex Nipple
CPG112	CO2 Y splitter
CPG411	Nipple RHT, 1/4" MPT
CPG412	Nipple LHT, 1/4" MPT
CPG413	Nipple CO2 Left Hand
CPG414	Nut CO2
CPG418	Pressure Relief Valve with Sleeve

Draft Beer Foam Preventer (FOB)

Stops beer flow immediately after a keg empties. It keeps the supply lines full of beer, even when a keg blows, to prevent them from filling with foam. Get fresh and clear beer from new keg saving time and money.

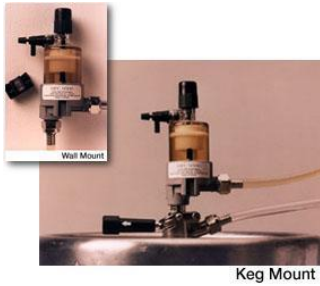

Pacific Beer Equipment FOB



Techflo FOB
10"Hx4"Wx3"D, 3/8" barb inlet/outlet, 3/16" ID JG drain

Item	Description
CPFOB100	Pacific FOB
CPFOB200	Techflo FOB
CPFOB201	SS FOB

Motors and Pumps



Item	Description
CPM813	1/3 HP (115V) 1725 RPM Rigid Base
CPM814	1/3 HP (115V) 1725 RPM Resilient Base
CPM815	1/3 HP (115V/ 230V) 1725 RPM Resilient Base



Procon Fluid-O-Tech Pump Insulation

Item	Description
CPM832	Procon , Brass Pump W/ Strainer, 100 GPH, 250 PSI
CPM833	Procon ,Brass Pump W/ Strainer, 125 GPH, 250 PSI
CPM835	Procon ,Brass Pump - No Strainer, 125 GPH, 250 PSI
CPM842	Fluid-O-Tech Brass Pump W/ Strainer, 100 GPH, 250 PSI
CPM843	Fluid-O-Tech Brass Pump W/ Strainer, 125 GPH, 250 PSI
CPM845	Fluid-O-Tech Brass Pump No Strainer, 125 GPH, 250 PSI
CPM830	Pump Insulation



Item	Description
CPM823	Flojet Beer Pump
CPM828	Flojet Flow Reversal Valve

Insulation Tube Closed Cell EPDM

Sold in 6 Ft. lengths.

Item	Description
FMT3412	3/4" X 1/2" Wall
FMT11812	1-1/8" X 1/2" Wall
FMT3434	3/4" ID X 3/4" Wall
FMT11834	1-1/8" ID X 3/4" Wall
FMT13834	1-3/8" ID X 3/4" Wall
FMT15834	1-5/8" ID X 3/4" Wall
FMT17834	1-7/8" ID X 3/4" Wall
FMT21834	2-1/8" ID X 3/4" Wall
FMT23834	2-3/8" ID X 3/4" Wall
FMT25834	2-5/8" ID X 3/4" Wall
FMT27834	2-7/8" ID X 3/4" Wall
FMT31834	3-1/8" ID X 3/4" Wall
FMT31234	3-1/2" ID X 3/4" Wall

- No mold or mildew growth
- Stays flexible in cold
- Works from -279 F to 300 F
- ASTM E 84 25/50 Flame and Smoke Rated

Contact us for any other sizes.



Item	Description
TPAL2	Aluminum Tape - 2" X 150 feet
TPAL3	Aluminum Tape - 3" X 150 feet
TP100	Vinyl Tape 3" X 66 feet
TP120	Foam tape - 2"x30 feet, 1/8" thick



New ! Taped Jacket Trunk Line

- 3/4" insulation
- Aluminum wrap for consistent temperature transfer
- Moisture barrier

**3/8" Glycol lines unless mentioned otherwise.
Also available with 1/2" Glycol lines.
Custom sizes are welcome.**

Glycol only line

Item	Description
CTRLT2-GL	2 Glycol – 3/8" ID
CTRLT4-GL	4 Glycol – 3/8" ID

3/8 ID Trunk Line

Item	Description
CTRLT2-38	2 Product / 2 Glycol
CTRLT4-38	4 Product / 2 Glycol
CTRLT6-38	6 Product / 2 Glycol
CTRLT8-38	8 Product / 2 Glycol
CTRLT10-38	10 Product / 4 Glycol
CTRLT12-38	12 Product / 4 Glycol
CTRLT14-38	14 Product / 4 Glycol
CTRLT16-38	16 Product / 4 Glycol

5/16" ID Trunk Line

Item	Description
CTRLT2-516	2 Product / 2 Glycol
CTRLT4-516	4 Product / 2 Glycol
CTRLT6-516	6 Product / 2 Glycol
CTRLT8-516	8 Product / 2 Glycol
CTRLT10+2-516	10 Product / 2 Glycol 1/2" Glycol lines
CTRLT10-516	10 Product / 4 Glycol
CTRLT12-516	12 Product / 4 Glycol
CTRLT14-516	14 Product / 4 Glycol
CTRLT16-516	16 Product / 4 Glycol
CTRLT20-516	20 Product / 4 Glycol 1/2" Glycol lines

1/4" ID Trunk Line

Item	Description
CTRLT4-14	4 Product / 2 Glycol
CTRLT6-14	6 Product / 2 Glycol
CTRLT8-14	18 Product / 2 Glycol
CTRLT10+2-14	10 Product / 2 Glycol (3/8" ID Glyco line)
CTRLT10-14	10 Product / 4 Glycol
CTRLT12-14	12 Product / 4 Glycol

3/8 ID Trunk Line

Item	Description
CTRL2-38	2 Product / 2 Glycol
CTRL4-38	4 Product / 2 Glycol
CTRL6-38	6 Product / 2 Glycol
CTRL8-38	8 Product / 2 Glycol
CTRL10-38	10 Product / 4 Glycol
CTRL12-38	12 Product / 4 Glycol
CTRL14-38	14 Product / 4 Glycol
CTRL16—38	16 Product / 4 Glycol

5/16" ID Trunk Line

Item	Description
CTRL2-516	2 Product / 2 Glycol
CTRL4-516	4 Product / 2 Glycol
CTRL6-516	6 Product / 2 Glycol
CTRL8-516	18 Product / 2 Glycol
CTRL10-516	10 Product / 4 Glycol
CTRL12-516	12 Product / 4 Glycol
CTRL14-516	14 Product / 4 Glycol

Extruded Jacket Trunk Line

- 3/4" insulation
- Tough and durable extruded jacket
- Flexible and easy to use
- Suitable for demanding environments - excellent physical properties



1/4" ID Trunk Line"

Item	Description
CTRL4-14	4 Product / 2 Glycol
CTRL6-14	6 Product / 2 Glycol
CTRL8-14	18 Product / 2 Glycol
CTRL10-14	10 Product / 4 Glycol
CTRL12-14	12 Product / 4 Glycol

Glycol Chillers – Power Packs



GLC380 : Kalinka Ice

- Upto 25' Run
- 1/6 hp compressor.
- 1150 BTU/hr, Glycol Tank : 2 gallon
- 115V/ 60Hz, Requires 15 amp Circuit
- Weight 42 lbs, 17"W x 19"D x 17" H



GLC381 : H35G Totton

- Upto 75' Run
- 3/8 hp compressor
- 2690 BTU/hr, Glycol Tank : 5 gallon
- 115V/ 60Hz, Requires 15 amp Circuit
- Weight 85 lbs, 28"W x 19"D x 18" H



GLC381-TALL : H75G Totton

- Upto 75' Run,
- 3/8 hp compressor
- 2690 BTU/hr, Glycol Tank : 5 gallon
- 115V/ 60Hz, Requires 15 amp Circuit
- Weight 86 lbs, 15"W x 18"D x 29" H



GLC384: H35G Procon

- Upto 125' Run
- 3/8 hp compressor
- 2690 BTU/hr, Glycol Tank : 7 gallon
- 115V/ 60Hz, Requires 15 amp Circuit
- Weight 95 lbs, 28"W x 19"D x 19" H



GLC384-TALL: H75G Procon

- Upto 125' Run
- 3/8 hp compressor
- 2690 BTU/hr, Glycol Tank : 7 gallon
- 115V/ 60Hz, Requires 15 amp Circuit
- Weight 96 lbs, 15"W x 18"D x 28" H



GLC385: LCB3500

- Upto 200' Run
- 1/2 hp compressor
- 3500 BTU/hr, Glycol Tank : 2 gallon
- 115V/ 60Hz, Requires 20 amp Circuit
- Weight 113 lbs, 13"W x 18"D x 28" H



GLC388: Extra 1/2

- Upto 250' Run
- 1/2 hp compressor
- 3900 BTU/hr
- Glycol Tank : 18 gallon
- 115V/ 60Hz
- Requires 20 amp Circuit
- Weight 155 lbs
- 24"W x 28"D x 30" H



GLC389: Extra 3/4

- Upto 450' Run
- 3/4 hp compressor
- 5500 BTU/hr
- Glycol Tank : 18 gallon
- 115V/ 60Hz
- Requires 20 amp Circuit
- Weight 161 lbs
- 24"W x 28"D x 30" H

Optional:
Additional pump
available on
GLC388 and GLC389

100% Propylene Glycol USP

Item	Description
CGL1	Glycol 1 Gallon
CGL5	Glycol 5 Gallon



Direct Draw Coolers

•HEAVY DUTY CONSTRUCTION

Top is made of solid 18" gauge stainless steel, including drip tray(s) for easy cleaning.

Wear-resistant black vinyl exterior, galvanized interior with durable stainless steel floor, and coved corners.

Drain is located in rear of cabinets to keep unit pristine at all times.

•STAY OPEN DOORS WITH LOCKS AND LIGHT

90° Stay open door feature and interior fluorescent light underneath the mullion.

•MAGNETIC GASKETS

Built of one piece, the gasket is removable without tools for ease of cleaning and replacement.

•ENHANCED REFRIGERATION SYSTEM

Factory engineered oversized and balanced refrigeration system. CFC free R-134a refrigerators maintain temperature between 33°F to 38°F, keeping beers ice cold.

SIDE MOUNT COMPRESSOR & FRONT BREATHING

System allows easy service and unrestricted placement of the unit.

•ANALOG THERMOSTAT

•INTERCHANGE DOORS

Field interchangeable doors from Solid to Glass or Glass to Solid based on operator's needs.

•OPEN CAVITY

Evaporator located on left side above compressor providing an open cavity and more working room.

•DDC23

Single keg units are rear breathing with internal drain, internal CO2 chain harness and with knockout place for external CO2 placement. Standard with 5" casters.



Model	Doors	Barrels	Amps	HP	Voltage	NEMA PLUG	Cabinet Dimensions			Shipping	
							L	D*	H	Wt. /	Cubes
DDC23	1	1	2.5	1/6	115/60/1	5-15P	24 ¼"	30 ½"	40 - 1/8"	165	23
DDC58	2	3	6.6	1/3	115/60/1	5-15P	59 ½"	28"	37	343	51
DDC68	2	3	6.6	1/3	115/60/1	5-15P	69 ½"	28"	37	370	59
DDC78	3	4	6.9	1/3	115/60/1	5-15P	80"	28 ½"	36 ¾"	396	68
DDC94	3	4	7.2	1/3	115/60/1	5-15P	95 ½"	28"	37	429	81

Beer Line Cleaning Solution

Chill Passion Beer Line Cleaner is a highly concentrated caustic non-foaming alkaline compound containing water conditioning agents, alkaline builders and a new patented surfactant.

- Highly Concentrated
- Superior Chelants
- Scale Inhibitors
- Dispersant
- Patented Surfactant
- Improved Cleaning
- Reduced Chemical Usage
- Reduced rinse water
- Reduced rinse time



Available in various sizes.

Removes Beer Stone | Kills all bacteria | Blue dye for rinse indication | Safe on beer lines

Free Freight on Pallet Orders !

Contiguous US only.
You can mix different sizes for a pallet.

Contact us for larger size drums.

Item	Description	Pallet size
CPLC55	Chill Passion Beer Line Cleaner - 55 gallon drum	4 drums, 220 gallons
CPLC1	Chill Passion Beer Line Cleaner - 1 Gallon	144 gallons
CPLC32	Chill Passion Beer Line Cleaner 32 oz bottle	432 bottles, 108 gallons
CPLC4	Chill Passion Beer Line Cleaner – 4 oz	

Item	Description	Pallet Size
CPALC1	Chill Passion Acid Line Cleaner - 1 Gallon	144 gallons

Cleaning Kits

- Strong HPDE Jar – holds 1000 ml
- All metal 4” pump

Faucet cleaning brush

Item	Description
CPCK904	Complete Cleaning Kit with 32oz cleaning liquid.
CPCK903	Complete Cleaning Kit with 4oz cleaning liquid.
CPCK910	Premium Cleaning Kit with 32 oz cleaning liquid. Includes easy cleaning attachment.
CPCK901	Pump / Jar assembly



Complete Line Cleaning Kit



Premium Line Cleaning Kit. Includes easy cleaning attachment



CPCK901 - Cleaning Jar assembly

New stronger bottle and cap to prevent cracking!

Cleaning Accessories



Item	Description
JS300	Medium Duty Re-Circulating Line Cleaning Pump
JS350 Plus	Heavy Duty Re-Circulating Line Cleaning Pump, Stainless Steel Pump
JS350 Plus-G	Heavy Duty, Re-Circulating Line Cleaning Pump, Stainless Steel Pump with gauge



C156
C156-316



C156.1



C299



C215



C157
CP562



C400

Item	Description
C156	Faucet / Shank cleaning attachment - Swivel w/ 3/8" barb
C156_316	Faucet / Shank cleaning attachment - Swivel w/3/16" barb
C156.1	Cleaning attachment only (no tail piece or washer)
C299	Faucet cleaning attachment - Fixed
C215	Duplex cleaning coupler
C157	Beer Line Cleaning Faucet Jumper 3/16" hose - 2 feet
CP562	Beer Line Cleaning Faucet Jumper 5/16" hose - 2 feet
C400	Keg coupler check ball lifter

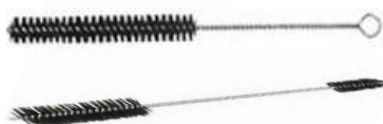

CB27



CB37



Item	Description
CB27	Heavy Duty Single Sided Brush
CB37	Double sided brush – Heavy duty

Item	Description
C395	Sankey cleaning adapter
CP392	Dual Sankey Cleaning Adapter with Check Ball Lifter

Easy cleaning attachment

Clean without removing faucets



CPC388

Great for cleaning Picnic Pumps too!

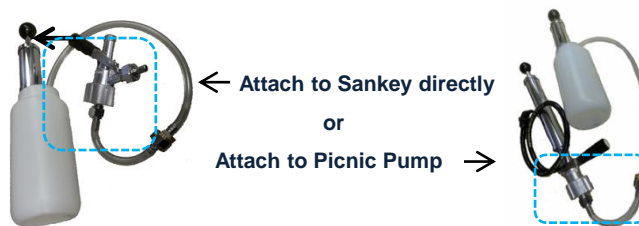

← Attach to Sankey directly
or
Attach to Picnic Pump →

Item	Description
CPC388	Complete easy cleaning attachment

- Attach any existing line cleaning kit to sankey directly for forward flush and quick cleaning. No need to disconnect faucet.
- Great for cleaning all types of Picnic pumps including Uber Tap.
- Includes fittings to attach to cleaning kit on one side and Keg coupler (sankey) on the other.

Picnic Pump assembly

High quality metal construction !

- Metal pump with metal piston.
- Highly durable.
- Chrome plated brass coupler.



For American Kegs (D style)

Item	Description
CPE85	D system with 4" pump
CPE86	D system with 8" pump

With European S coupler

Item	Description
CPE85S	S System with 4" pump
CPE86S	S System with 8" pump



Cleaning Kit for party pumps !

Complete Kit for cleaning party pump assembly.

Order item **CPC910 (Page 34)** or just the adapter - **CPC388**

For Homebrew Soda Kegs

Item	Description
CPE86C	8" pump with ball lock disconnect



Premium Upright Picnic Pumps

- * Convert a coupler (Keg Tap) into a supreme Keg Party Pump.
- * All metal parts for more durability and life.
- * Includes chrome faucet & knob.
- * Purchase coupler separately or use with your existing coupler..



Upright convertor assembly

Item	Description
CPE83	Upright convertor assembly with 4" pump
CPE84	Upright convertor assembly with 8" pump



See Page 35 for Upright assembly with mini CO2 cartridge

Picnic Pumps for Import Beers



8" pump , coupler , 4' of hose and faucet. Fully assembled.

Item	Description
CPSPE86D	Side pump assembly & coupler – D American
CPSPE86S	Side pump assembly & coupler – S European
CPSPE86U	Side pump assembly & coupler – U Guinness
CPSPE86A	Side pump assembly & coupler – A German
CPSPE86G	Side pump assembly & coupler – G Bass

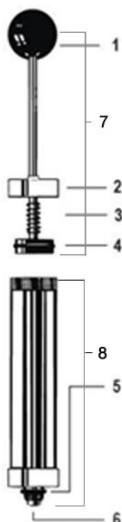

Ref#	Item	Description
1	CPE93.8	Round Black Knob
2	CPE93.2	Top Cap
3	CPE93.7	Piston Spring
4	CPE93.5	Pump O-Ring
7	CPE93.22	4" Piston assembly
7	CPE94.22	8" Piston assembly
8	CPE93.1	4" Pump tube assembly
8	CPE94.1	8" Pump tube assembly

Item	Description
CPE93	4" pump
CPE94	8" pump
CPE85.1	Picnic Coupler – D
CPE85S.1	Picnic Coupler – S



Complete Pump with threads and check valve



Coupler for Picnic Pump

Mini CO2 Setup – Ready to go wherever you are !

Various kits available to use with any kind of setup. No need to carry bulky CO2 cylinders and regulators. Use them on the go, in parties, events or even in your home.

All Mini CO2 kits come assembled and ready to use.

Regulator is easy to use, easy to carry and pressure can be adjusted by turning the knob.

Includes a pack of 2 CO2 cylinders – 74 gm ea.

Box packed and ready to sell.



CPDKG320

Complete kit including gas and liquid lines



CPDKG321

Gas line CO2 kit



Item	Description
CPDKG320	Ball lock complete assembly with mini CO2 kit
CPDKG321	Ball lock gas disconnect with mini CO2 kit



UTG201D

Uber Tap with mini CO2 kit



CPUG384

Upright assembly with mini CO2 kit



CGMK134

Mini CO2 kit – Add on to any existing setup

Item	Description
UTG201D	Uber Tap 3 way, D system with mini co2 kit
CPUG384	Upright party assembly, D system with mini co2 kit
CGMK134	Mini CO2 kit, Add on to any existing setup



CO2 Cartridge

CO2 and Argon Cartridges come in disposable cartridges with 5/8" threads.

Item	Description
CGC174	CO2 cartridge refills 74 grams– Set of 2
CGA274.1	Argon cartridge refills 26 grams– 1 Piece



Argon Cartridge

Best for use with Wine Dispensing

New !



Uber Tap – Picnic Pumps

Ubertap combines a foot pump with multi-faucet dispensing to deliver beer 5 times faster than the common keg tap.

Ubertap foot pump pushes **26.69 cubic inches** per depression (Traditional 4" hand pump - 9.42 cubic inches per depression).

All metal splitter for durability.
Also available in single faucet models.



Most Popular



UT201 – 3 faucet party pump
Includes tri splitter, foot pump and coupler.

- Multiple faucets create a rapid, easy, transition for partygoers - 5x quicker than the common keg tap.

-The foot pump provides superior pumping to a traditional hand pump, allowing consumers to pump at a faster rate delivering greater pressure per depression.

- Creates a more consistent flow of beer, and the hands-free method makes it much easier to pump while holding the faucet and cup.

-Durable construction to last long.



UT202 – 1 faucet party pump
Includes foot pump and coupler.



UT203 – upright party pump assembly
Includes foot pump, coupler, and upright rod with faucet and knob.

Item	Description
UT201D	3 way complete Uber Tap assembly – D Coupler
UT202D	1 Tap complete Uber Tap assembly – D coupler
UT203D	Upright complete assembly with Foot pump – D Coupler
UT201S	3 way complete Uber Tap assembly – S Coupler
UT202S	1 Tap complete Uber Tap assembly – S Coupler
UT203S	Upright complete assembly with Foot pump – S Coupler
UT101	Uber Tap 3 way splitter
UT102	Uber Tap Foot Pump



C238

C238H2

C238H4

Item	Description
C238	Picnic faucet
C238H2	Picnic faucet with 2" hose
C238H4	Picnic faucet to beer coupler – 4" hose



C151



C396

Item	Description
C151	Clamp Set (Purchase 2 sets for one complete assembly)
C396	5/16" Barb to Threaded adapter
C150	Upright rod
CSS150	Upright Rod, All SS304

Now available in all SS304 contact!



C150
CSS150

Jockey Box – Coil or Cold Plate

Assembled in USA

We can make various configurations of Jockey boxes with cooling coils or cold plates. Just ask for what you need.

- Coleman coolers.
- Includes Faucets and Knobs.
- Colors may vary.
- Ask if you need a specific color.
- Built with leak proof hardware.



Coleman Ice Chest		Up to 4 Lines with coils.		Coleman 54 qt. Steel Belted Cooler
Item	Cooler	Faucets	Line Size	Item
CJB9150	9 quart	1	50' Coils	-
CJB9150H	9 quart	1	50' coil + 6' beer line, 1/4" FFL fitting	-
CJB48150	48 quart	1	50' Coils	CJB54M150
CJB48250	48 quart	2	50' Coils	CJB54M250
CJB48350	48 quart	3	50' Coils	CJB54M350
CJB48450	48 quart	4	50' Coils	CJB54M450
CJB48170	48 quart	1	70' Coils	CJB54M170
CJB48270	48 quart	2	70' Coils	CJB54M270
CJB48370	48 quart	3	70' Coils	CJB54M370
CJB48470	48 quart	4	70' Coils	CJB54M470
CJB481120	48 quart	1	120' Coils	-
CJB482120	48 quart	2	120' Coils	-
CJBC10151	48 quart	1	10x15 Cold Plate	CJB54MC10151
CJBC10152	48 quart	2	10x15 Cold Plate	CJB54MC10152

Steel Belted Jockey Boxes



Upgrade to all SS304 contact!

Add "-SS" to the item number for SS304 version.



CPCL50 – 50 feet SS Cooling Coil

- 50' x 5/16" OD Stainless Steel
- Coil height: 6.75" Coil OD: 5.25"
- Purchase Beer Nut ,Ferrules , Grommets separately: 2x (CL172, CL272, C181)



CPCL70 – 70 feet SS Cooling Coil

- 70' x 5/16" OD Stainless Steel
- Coil height: 9.5 'Coil OD: 5.25"
- Purchase Beer Nut ,Ferrules , Grommets separately : 2x (CL172, CL272, C181)



CPCL120 – 120 feet SS Cooling Coil

- 100' x 3/8" OD and 20'x1/4" OD SS
- Coil height: 9.-1/2'Coil Width: 9-3/4"
- Purchase Beer Nut , Ferrules , Grommet separately: 1x (CL171, CL271, C181) 1x (CL173, CL273, C181)

Item	Description	Length
CPCL50	SS cooling coil 50'	50'
CPCL70	SS cooling coil 70'	70'
CPCL120	SS cooling coil 120' - Square	120'

Coils do not include Ferrules, Grommets or Beer Nuts. Please purchase separately if needed.



Item	Description
CL171	Ferrule for 1/4" coil
CL172	Ferrule for 5/16" coil
CL173	Ferrule for 3/8" coil
CL271	Grommet for 1/4" coil
CL272	Grommet for 5/16" coil
CL273	Grommet for 3/8" coil



Item	Description
C301S.1	Black Rubber Washer
CP9SSW	SS Washer



Beer Coil cooler wall coupling
Chrome plated brass or SS304



Jockey Box
ID: 1/4" x 5/16" (for 5/16" coils)
CP Brass or SS304

Item	Description
C132	3" Ice Box Assembly with 5/16" Bore – CP Brass
C132-38	3" Ice Box Assembly with 3/8" Bore – CP Brass
C131	4.5" Ice Box Assembly with 3/8" Bore – CP Brass
CSS131	4.5" Ice Box Assembly with 3/8" Bore – SS304
C301S	3" Shank (1/4" x 5/16" bore)
CSS213J	3-1/8" Shank SS304 (1/4" x 5/16" bore)

CMB Plastic Disconnects



Item	Description
CPPD100	Ball Lock Plastic Disconnect MFL – Gas
CPPD101	Ball Lock Plastic Disconnect MFL – Liquid
CPPD200	Ball Lock Plastic Disconnect 1/4" Barb – Gas
CPPD201	Ball Lock Plastic Disconnect 1/4" Barb – Liquid

Item	Description
CPPD300	Pin Lock Plastic Disconnect MFL – Gas
CPPD301	Pin Lock Plastic Disconnect MFL – Liquid
CPPD400	Pin Lock Plastic Disconnect 1/4" Barb – Gas
CPPD401	Pin Lock Plastic Disconnect 1/4" Barb – Liquid



CPPD600
Ball Lock with 1/4" MFL



CPPD700
Pin Lock with 1/2" MFL

CMB Disconnects with check valve

Item	Description
CPPD600	Ball Lock Plastic Disconnect 1/4" MFL – integrated check valve
CPPD700	Pin Lock Plastic Disconnect 1/2" MFL – integrated check valve

Pre-Mix Dispensing Valves

Item	Description
CPV750	Pre Mix Dispensing Valve with 1/4" MFL Yoke
CPPD700	Per-Mix Squeeze Valve with 1/4" Barb



CPV750
Pre Mix Dispensing Valve
With 1/4" MFL Yoke



CPV850
Per-Mix Squeeze Valve
With 1/4" Barb

Bib Connectors and Sanitizing Adapters



CBIB100



CBIB200



CBIB300



CBIB400

Item	Description
CBIB100	Red Bib Connector for Coke
CBIB200	Green Bib Connector for Pepsi Encore
CBIB300	Grey QCD II connector
CBIB400	Purple BIB Connector (Works with certain Dr. Pepper Bags)



CBIB110



CBIB210



CBIB211



CBIB310

Item	Description
CBIB110	Red Sanitizing adapter for Coke
CBIB210	White Sanitizing adapter for QCD Encore
CBIB211	Green Sanitizing Adapter for Pepsi Encore
CBIB310	Flush Adapter Slider Q51/QFS/Q21



C115 – Tail Piece with 1/4" MFL connector - SS
Fits inside a hex nut or wing nut . Provides a 1/4" MFL connection, so you can easily change between commercial kegs and homebrew kegs.



C118 – Corny Plug Adapter - SS
Male end has 19/32"-18 threads. The other end is a standard 1/4" female flare (FFL).



CP9350 – Swivel Female Flare – Brass
1/4" MFL X 1/4" MFL

Item	Description
C115	Tail piece with 1/4" MFL connector
C118	Corny plug adapter
CP9350	Swivel Female Flare

Adapter to connect faucet and quick disconnect



C119



C109



Keq coupler conversion adapter

Quickly connect ball lock disconnect to keg coupler.

Item	Description
CP931	Liquid Ball Lock to Female Beer thread
CP932	Gas Ball Lock to Female Beer thread

Item	Description
CF810	Faucet Adapter & Coupling nut kit
C119	Coupling nut only
C109	Adapter – Chrome only



Sampling faucet –ball lock

Flare Swivel Nut & Stem Set- Stainless Steel



Item	Description
CF914	1/4" FFL X 1/4" Barb (includes separate nut and stem)
CF915	1/4" FFL X 5/16" Barb (includes separate nut and stem)
CF916	1/4" FFL X 3/8" Barb (nut and stem single piece)
CF917	3/8" FFL X 1/2" Barb (nut and stem single piece)

Item	Description
CPPDK38	Sampling Faucet

Nylon Flare Washers

Priced per pack of 100



Item	Description
CF9501	1/4" Nylon Washer WHITE
CF9502	5/16" Nylon Washer RED
CF9503	3/8" Nylon Washer BLACK
CF9504	1/2" Nylon Washer WHITE

Wort chiller

-3/8" OD x 25' Long Copper Coil
-Clear hose with garden hose connection included



Item	Description
C281	Stainless Steel wort chiller
C219	Copper wort chiller

C999 – 21" Stainless Steel Spoon

Rugged spoon is great for stirring a mash.
Corrugated design prevents bending.



CP997 – 30" Stainless Steel Mash Paddle

Item	Description
C999	21" Stainless Steel Spoon
CP997	30" Mash Paddle – Stainless Steel

False Bottoms – Stainless Steel



Material SS 304

CSS921 – Stainless Steel false bottom 9”
 CSS922 – Stainless Steel false bottom 10”
 CSS923 – Stainless Steel false bottom 12”

Item	Description
CSS921	False bottom 9”
CSS922	False bottom 10”
CSS923	False bottom 12”

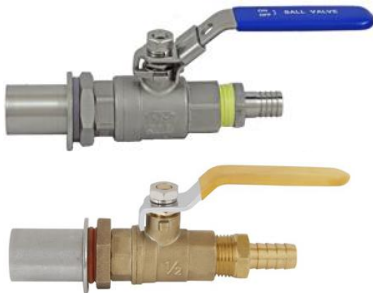

Kettle Conversion Kit

Easily converts any kettle without welding.
 All that is needed is a 7/8" holesaw, step- drill ,
 or hole punch and pliers.

Item	Description
CSS918	Kettle conversion kit – SS304
C218	Basic Kettle conversion kit



Item	Description
CP9SSC	SS socket
CP9SSW	SS washer
CP9FSW	Flat silicon washer
CP9CN1	SS Cross Nipple 1” long 1/2” NPT
CP9OR	Silicon O Ring
CSS921.2	SS 304 Hex Nut with groove
CSS918.1	SS Ball valve 1/2” FPT X 1/2” FPT
CP9BARB12	SS Barb nipple
C218.1	Brass Ball Valve 1/2” FPT X 1/2” FPT
C218.2	Brass Barb nipple
CSS921.1	Elbow nipple for false bottom

Bazooka Screen



Item	Description
CSS924	Bazooka Screen - 6” long. 1/2” MPT
CSS925	Bazooka Screen -12” long. 1/2” MPT



C711 Pure screen – Stainless Steel 304

The Pure Screen is a welded stainless steel screen that slips onto your racking cane or keg dip tube and filters out fruit or dry hops from the fermented or whole hops and trub from the kettle

Item	Description
C711	Pure Screen



C162– Wine Agitating Rod - Fizz X

The wine agitating rod eliminates the hassle of shaking and stirring. Connects to standard drill machine .

* Stainless Steel Construction



Racking Cane with tip – Stainless Steel

C165 - 3/8"OD x 30"

Item	Description
C162	Wine Agitating Rod
C165	Racking Cane – 30"



C166 - Replacement tip for 3/8" racking cane



Item	Description
C166	Replacement tip for racking cane

C148 – Chrome Plated Brass Jet and Carboy Washer
 Jet Bottle Washer: Attaches to your faucet, this device delivers a blast of water to clean bottles and carboys. A faucet adapter (sold separately) is needed to connect to your kitchen sink.



C248 – Faucet Adapter for Jet Carboy Washer

Item	Description
C148	Jet and Carboy washer
C248	Faucet adapter



C170 - Carboy Handle 6.5 Gallon

For one handed lifting of empty glass carboys

Item	Description
C170	Carboy Handle 6.5 Gallon

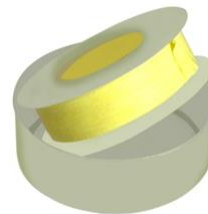

Item	Description
CP154	Teflon Tape 1/2"x472"
C249	Keg Lid O-Ring



CPCCM201
Chrome plated brass kit



CPCCM203
Stainless Steel 304 kit

Faucet and Shank Kit

Boxed kit contains faucet, 4" shank with nipple and knob



Item	Description
CPCCM201	Faucet and Shank kit –Chrome
CPCCM203	Faucet and Shank kit – SS 304



Item	Description
CGC5	Catalina Cylinder 5lb empty



Item	Description
CPCCM101	5' of 3/16" clear beer hose with hex nut fittings on one end
CPCCM102	5' of 3/16" clear beer hose with hex nut fittings on both ends
CPCCM103	5' of 3/8" beer hose with hex nut fittings on both ends – Use for Jockey box connection to standard keg coupler
CPCCM104	5' of 1/4" beer hose with 1/4" MFL to hex nut fitting. – Use for Jockey box connection to Soda/ Homebrew disconnect

Refrigerator Conversion and Home Brew Kegging Kits



Commercial Beer kit (1 or 2 line) Includes:

- * 5 lb CO2 cylinder – empty (Optional)
- * Faucet and Shank assembly
- * Faucet knob
- * Fully assembled Beer line
- * Air hose and clamps
- * 2 gauge regulator
- * American Sankey
- * Drip Tray
- * Faucet wrench and cleaning brush.

Home Brew kit (1 or 2 line) Includes:

- * 5 lb CO2 cylinder with air hose and ball lock gas disconnect
- * 2 gauge regulator

+

- * Faucet/Shank assembly with knob
- * Drip Tray
- * Faucet wrench and cleaning brush
- * Beer line with ball lock disconnect

OR

- * Beer line with plastic faucet and ball lock disconnect

Item	Description
CRCK101C	Single Tap Commercial Kit with cylinder
CRCK101	Single Tap Commercial Kit without cylinder
CRCK102C	Double Tap Commercial Kit with Cylinder
CRCK102	Double Tap Commercial Kit without Cylinder
CRHK901C	Single Tap Home Brew Refrigerator Kit with Cylinder
CRHK902C	Double Tap Home Brew Refrigerator Kit with Cylinder
CRHK900C	Single Tap Home Brew Kegging Kit with Cylinder

**For latest catalog and
announcements visit our website:**

www.chillpassion.com

Limited One Year Warranty

Chill Passion Inc. warrants that its products will be free from defects in material and workmanship, under normal use, regular service and preventative maintenance for 1 year from the date of sale.

Warranty is for first- end users only. Some products which are not made by Chill Passion Inc. are warranted by their respective manufacturer, therefore, this limited warranty does not apply to such products.

If any defect is discovered, Chill Passion Inc., after receipt and inspection will at its option, either repair, replace or refund the price of the item. Other costs incidental to replacement including labor cost, loss of sales and/or loss of product must be borne by the user. This warranty does not cover failure due to abuse, improper usage, or progressive wear and tear.

Hours

Hours Monday through Friday: 8:30 am- 5:00 pm CST.

Ordering Procedure

Phone orders can be placed at 630-372-7005 during regular business hours. Orders can be faxed to (630) 823 8486 or emailed to sales@chillpassion.com.

While many items can be shipped within 2-3 days of order placement, the standard lead time on build-to-stock items is 5-7 business days. Lead time on custom items and other items may vary.

Receiving Merchandise

Inspect your shipment when it is delivered. If your package has arrived damaged or otherwise tampered with, notify your delivery person immediately. Customers are responsible for checking their order when it arrives to ensure that all items are present. If there are any discrepancies, please notify immediately(within 5 business days). Chill Passion Inc. is not responsible for missing items unless notified by customer within the allowed period. In the event of merchandise damaged in shipment, please retain merchandise, records and all packing materials for inspection by carrier.

Terms

All orders are sent FOB Streamwood, IL. We accept all major forms of payment. Any invoice past 30 days will delay future shipments. Chill Passion Inc. reserves the right to change the prices and specifications of equipment and/or material without notice. We reserve the right to correct printing errors.

Return Policy

Authorization is required for any merchandise return. Describe the items being returned and the reason. All returned items must be unused and in original condition including the original packaging, documentation, manuals and accessories. All returns are subject to a minimum 15% handling and restocking charge. Build to order items and custom sizes are not returnable.

Customers are responsible for all shipping charges. Freight must be prepaid on all returned parts. Chill Passion Inc. is not responsible for returned shipments that are lost, pilfered, or damaged.

Chill Passion

www.chillpassion.com

All Rights Reserved